



Czech Technical University in Prague

Faculty of Electrical Engineering
Department of Economics, Management and Humanities

ANALYSIS OF ENERGY SAVINGS MEASURES IN PUBLIC BUILDING IN RUSSIAN FEDERATION

MASTER THESIS

Study program: Electric Power Generation and Transportation

Field of study: Electrical Engineering, Power Engineering and Management

Scientific supervisor: Ing. Tomáš Králík, Ph.D.

Anastassiya Chernaya

Prague 2017

I. OSOBNÍ A STUDIJNÍ ÚDAJE

Příjmení: **Chernaya** Jméno: **Anastasiya** Osobní číslo: **466086**
Fakulta/ústav: **Fakulta elektrotechnická**
Zadávající katedra/ústav: **Katedra ekonomiky, manažerství a humanitních věd**
Studijní program: **Elektrotechnika, energetika a management**
Studijní obor: **Ekonomika a řízení energetiky**

II. ÚDAJE K DIPLOMOVÉ PRÁCI

Název diplomové práce:

Analysis of energy savings measures in public building in Russian Federation

Název diplomové práce anglicky:

Analysis of energy savings measures in public building in Russian Federation

Pokyny pro vypracování:

- perform the analysis of currently implemented energy efficiency measures in RF
- perform the analysis of energy consumption and description of given public building
- identify and design suitable energy savings measures for given public building
- conduct technical and economic evaluation of proposed energy savings measures

Seznam doporučené literatury:

- 1) SHAPIRO, Ian M. Energy audits and improvements for commercial buildings. ISBN 9781119084167.
- 2) SINGH, Jas. Public procurement of energy efficiency services: lessons from international experience. Washington, D.C.: ESMAP/Energy Sector Management Assistance Program, c2010. Directions in development (Washington, D.C.). ISBN 0821381024.
- 3) Federal law from 23.11.2009 N 261-FZ (edited 13.07.2015) ?About energy savings and increase of electrical efficiency and about amendments in certain legislative acts of Russian Federation?.

Jméno a pracoviště vedoucí(ho) diplomové práce:

Ing. Tomáš Králík Ph.D., katedra ekonomiky, manažerství a humanitních věd FEL

Jméno a pracoviště druhé(ho) vedoucí(ho) nebo konzultanta(ky) diplomové práce:

Datum zadání diplomové práce: **17.02.2017**

Termín odevzdání diplomové práce: **26.05.2017**

Platnost zadání diplomové práce: **25.05.2018**

Podpis vedoucí(ho) práce

Podpis vedoucí(ho) ústavu/katedry

Podpis děkana(ky)

III. PŘEVZETÍ ZADÁNÍ

Diplomantka bere na vědomí, že je povinna vypracovat diplomovou práci samostatně, bez cizí pomoci, s výjimkou poskytnutých konzultací. Seznam použité literatury, jiných pramenů a jmen konzultantů je třeba uvést v diplomové práci.

Datum převzetí zadání

Podpis studentky

DECLARATION:

I hereby declare that this master's thesis is the product of my own independent work and that I have clearly stated all information sources used in the thesis according to Methodological Instruction No. 1/2009 – "On maintaining ethical principles when working on a university final project, CTU in Prague".

May 2017

Anastassiya Chernaya

ABSTRACT

Present diploma thesis focuses on the concept of energy efficiency. The main purpose of the research is development of energy saving measures and increasing of the level of energy efficiency in the educational building. It is known that energy efficiency concept is one of the most up-to-date directions in the field of Power Engineering. Every country is trying to develop measures which will allow using of electrical energy in more rational way. My research is based on the educational building which is located in Russian Federation. Based on the government support and actual acts of law of Russian Federation I offer possible electrical energy savings measures in the paper. The paper provides detailed description of the public building current condition and based on gathered information it offers all possible energy efficiency measures, which depends on various factors.

To distinguish all possible measures, I conducted detailed analysis of electrical energy consumption in education building. During the evaluation, I distinguished some measures which do not require any initial investments. As well to increase rate of energy efficiency of the building I provided the calculation of modern automatic lighting control system implementation. Finally, I calculated economical evaluation and estimation of possible savings for all offered measures.

KEYWORDS

Energy efficiency concept, decreasing of electrical energy consumption in public buildings, energy savings measures.

CONTENTS

ABSTRACT	8
KEYWORDS.....	8
LIST OF APPENDICES	6
LIST OF FIGURES.....	7
LIST OF TABLES.....	8
LIST OF ABBREVIATIONS	9
INTRODUCTION.....	10
1. Review of the main issue in the field of energy efficiency	11
1.1 The analysis of world energy consumption dynamic	11
1.2 Energy efficiency concept.....	12
1.3 The existing situation of energy efficiency implementation in Czech Republic	13
2. Analysis of currently implemented energy efficiency measures in Russian Federation	15
2.1 Description of passed law to increase energy efficiency level	15
2.2 Description of achieved results after implementation of the law.....	15
3. Analysis of energy consumption and description of given public building conditions	17
3.1 General description of the subject of research.....	17
3.2 Analysis of energy consumption by considered educational building.....	18
3.3 Analysis of factors which influence on electrical energy consumption	21
3.4 The main electrical energy consumers in educational building.....	23
4. Identifying and designing of suitable energy savings measures for considered public building	24
4.1 Possible energy efficiency measures	24
4.2 Analysis of electrical energy consumption structure	25
4.2.1 Energy efficiency measures based on electrical energy consumption analysis	27
4.2.2 Elimination of irrational electrical energy consumption rate.....	30
4.3 Analysis of enveloping measures implementation.....	31
4.4 Energy efficiency measures based on controlling and load reduction	32
4.4.1 Lighting system reconstruction.....	32
4.4.2 Automatic control of lighting level in classes	36
4.4.3 Technical realization of lighting level control system in lecture rooms	38
5. Economic evaluation of proposed energy saving measures	45
5.1 Methodology of economic evaluation.....	45
5.2 Economic evaluation of measures which do not require any initial investments.....	46

5.2.1 Sensitivity analysis for heaters elimination measure.....	47
5.3 Economic evaluation of building insulation.....	49
5.3.1 Sensitivity analysis of building insulation measure.....	50
5.4 Economic evaluation of lighting system reconstruction project.....	52
5.4.1 Sensitivity analysis for lighting system reconstruction.....	53
5.5 Analysis of considered variants	55
CONCLUSION.....	57
REFERENCES.....	58
APPENDICES.....	60

LIST OF APPENDICES

Appendix 1 - Educational building plan [13].....	60
Appendix 2 - Linear schedule of educational process [13].....	61
Appendix 3 - External power supply scheme of educational building [10]	62
Appendix 4 - Scheme of light sources arrangement in the lecture room	63

LIST OF FIGURES

Figure 1 - World electrical energy consumption [3]	12
Figure 2 - Educational building location [15]	17
Figure 3 - Structure of educational building rooms.....	18
Figure 4 - Energy consumption dynamic [11]	19
Figure 5 - Electrical energy price changing dynamic.....	20
Figure 6 - Electrical energy payment changing dynamic	20
Figure 7 - Daylight duration change in November [14]	21
Figure 8 - Average electrical energy consumption for working day in November [11].....	22
Figure 9 - Average daily temperature and electrical energy consumption change in November 2015 [11].....	22
Figure 10 - Structure of electrical energy consumption in educational building	23
Figure 11 - Primary categories of energy efficiency measures.....	24
Figure 12 - Core ways of energy efficiency measure implementation	25
Figure 13 - Electrical energy consumption during 2014 year [11].....	26
Figure 14 - Electrical energy for each season [11].....	26
Figure 15 - Average installed power for every season [11]	27
Figure 16 - EE consumption during a day in winter depending on outside temperature [11].....	28
Figure 17 - EE consumption during a day in September depending on outside temperature [11] ...	28
Figure 18 - Average electrical energy consumption in February and September days [11]	29
Figure 20 - Changing of lighting flow by fluorescent lamps during their lifetime period [24]	35
Figure 21 - Changing of lighting flow by LED lamps during their lifetime period [25].....	36
Figure 22 - Daylight extension in a lecture room [26]	37
Figure 23 - Operational principle of smooth lighting adjustment	37
Figure 24 - Scheme of lecture room	39
Figure 25 - Curves of changing natural lighting level on the tables located in front of lighting aperture area	40
Figure 26 - Curves of changing lighting level on the tables located between lighting aperture area	40
Figure 27 - Trendlines of natural lighting level	41
Figure 28 - Scheme of automatic lighting control system	42
Figure 29 - Dependence NPV on inflation rate	47
Figure 30 - NPV dependence on real discount rate.....	48
Figure 31 - NPV dependence on electrical energy consumption rate	48
Figure 32 - NPV dependence on heating rate changing	49
Figure 33 - Dependence NPV on inflation rate	50
Figure 34 - NPV dependence on real discount rate.....	51
Figure 35 - NPV dependence on investment changing rate	51
Figure 36 - Dependence NPV on inflation rate	53
Figure 37 - NPV dependence on real discount rate.....	54
Figure 38 - NPV dependence on electrical energy consumption rate.....	54
Figure 39 - NPV dependence on different number of room measures implementation	55

LIST OF TABLES

Table 1 - Thermal and electrical energy consumption data for 8 years period [5]	18
Table 2 - Thermal and electrical energy consumption data in MWh units	19
Table 3 - Power engineering institute students number	21
Table 4 - Average installed power for every season [11]	27
Table 5 - Electrical energy consumption for average day in February and September [11]	30
Table 6 - Results of heat insulation efficiency	31
Table 7 - Technical parameters of Philips Standart 18W FL	34
Table 8 - Technical parameters of DS-Office-30 LED lamps.....	35
Table 9 – Coefficients dependence on natural lighting level.....	41
Table 10 - Consumed electrical energy in case of turning off lighting installation during different periods of time.....	43
Table 11 - Consumed electrical energy in case of turning off lighting installation during different periods of time.....	44
Table 12 - Initial data for local heaters elimination project evaluation	46
Table 13 - Calculated data for economical evaluation of local heaters replacement	47
Table 14 - Initial data for building insulation project evaluation	49
Table 15 - Calculated data for economical evaluation of building insulation	50
Table 16 - Initial data for lighting reconstruction project evaluation.....	52
Table 17 - Calculated data for economical evaluation	52
Table 18 - Efficiency of saving measures implementation	56

LIST OF ABBREVIATIONS

CZ – Czech Republic

CZK – Czech Crown

DPBP – Discounted Payback Period

EE – Electrical energy

EED – Energy Efficiency Directive

EU – The European Union

FL – Fluorescent lamps

FZ – Federalnyy zakon

GDP - Gross Domestic Product

IEO2016 – International Energy Outlook 2016

IRR – Internal Rate of Return

LED – Light Emitting Diod

LH – Local heaters

NPV – Net Present Value

RF – Russian Federation

Rub – Ruble

TE – Thermal energy

INTRODUCTION

Nowadays there is a tendency of world energy consumption rate growth. It means that every year more energy is consumed and more energy is generated by power plants, consequently, more resources are used for electrical energy generation. However, it is known that energy sources are limited. Undoubtedly, renewable energy sources usage rate is growing and this tendency is very popular. However, currently the main part of electrical energy source is still fossil fuel. Growing demand of electrical energy consumption directly connected with constantly growing needs of modern society and development of new technologies, which could be energy demanded. Keeping in the mind these facts the importance of rational energy sources usage is appeared. With understanding of this fact, the importance of energy efficiency measures implementation is on the same stage with the importance of new energy sources development. In my work, I consider ways of energy consumption decreasing on the example of public building [2].

Currently energy resources in public buildings are used irrationally. According to requirements of MC ISO 50001:2014 each public organization have to provide system analysis of consumed energy resources to distinguish the rate of their effective usage. In my work, I conduct a detailed analysis of energy sources consumption by educational building located in Russian Federation.

According to Federal law from 23.11.2009 N 261-FZ in educational buildings there have to be created measures which will allow decreasing of energy and resources consumption (volume of consumed water, diesel fuel or other types of fuel, natural gas, thermal and electrical energy) minimally by 3% per a year during the next five years [1]. Based on the law the main purpose of my work is analyzing of all possible measures which can be implemented in educational building and designing of energy saving measures which will be applicable for considered educational building in current conditions.

My work consists of five main parts. Firstly, I provide the analysis of electrical energy consumption throughout the world and explain the meaning of energy efficiency concept and the reason why energy efficiency measures have to be implemented. In the second part of my work I provide the analysis of existing situation of energy efficiency measures implementation in considered country based on issued government lows. The next part of my work includes detailed description of current conditions of considered building. It includes general description of the building (location, size, plan, climate in the region and ext.), detailed analysis of electrical energy consumption structure in the educational building, analysis of factors which influence on electrical energy consumption and analysis of the main electrical energy consumers in the educational building. Then, I analyze all possible energy efficiency measures which can be implemented in educational building. However, due to limitation of financing further in my work I consider measures which demand minimum investments but have sufficient positive output from implementation. Finally, I provide economical evaluation of all offered measures. For each measure, I conduct sensitivity analysis to understand possible influence of external factors. Then I provide a comparison of effectiveness of offered energy efficiency measures implementation from economical point of view.

1. Review of the main issue in the field of energy efficiency

1.1 The analysis of world energy consumption dynamic

According to research provided by US Energy information administration the world net electricity generation from 2012 till 2040 has been increased on 69%, from 21,6 trillion kWh in 2012 to 25,8 trillion kWh in 2020 and 36,5 trillion kWh in 2040. Electricity consumption rate is the fastest growing type of end-consumers utilities [2].

Electricity level consumption demand rate rise is strongly connected with economic growth of a country. As it is noticed in International Energy Outlook 2016 report world gross domestic product (GDP) rise is gradually slowing down in comparison with the last 20 years, however, electricity demand is continuously increasing, especially among countries which are not parts of Organization of Economic Cooperation and Development (non-OECD countries). According to statistic data in 2012, electricity generation rate in non-OECD countries was almost a half from electrical energy generation in the entire world. Moreover, with constant economic growth in non-OECD countries electricity demand is growing as well [3].

Over the past several decades throughout the world a set of primary electrical energy sources has been a little bit changed. Nevertheless, according to statistical data coal is considered to be the fuel which is the most widely used in electricity generation, but due to bad influence to environment and tries to implement other energy sources the coal started to be not so popular in usage. It is possible to notice that the rate of electrical energy generated by nuclear power stations is significantly increased from the 1970s till the 1980s, and electrical energy generated in a way of natural gas-firing is increased after the 1980s. However, during this period of time the use of oil for electrical energy generation decreased due to significant oil prices growth [2].

Environmental consequences of greenhouse gas emissions and rapid growth in development of renewable energy sources brought the main influence on electrical energy consumption rate in the early 2000s. On the same time, natural gas started to be more widely used due to the fact that this fossil fuel emits significantly less amount of carbon dioxide than oil or coal per 1 kWh generated. The IEO2016 Reference case promotes support of electrical energy generation from natural gas, nuclear, and renewable energy sources. Moreover, the most prospective direction in electrical energy generation changes are considered renewable energy sources which, nowadays, are the fastest-growing source of electrical energy generation. During the period from 2012 till 2049 according to forecast of IEO2016 Reference electrical energy generation by renewables increased in average on 2,9%. As well it is reported that non-hydropower renewable energy sources are one of the fastest growing sources of electrical energy generation. In 2012 such renewables have been taken 5% of total world electricity generation and as it is estimated in IEO2016 that in 2049 the share of non-hydropower renewables will be 14% [2].

According to IEO2016 Reference, after renewable energy sources, natural gas and nuclear power are the next fastest growing sources of electricity generation. Based on forecast during the period 2012-2040 the rates of increasing natural gas-fired electricity generation and nuclear power generation are 2,7% per a year and 2,4% per a year, consequently. Thus, it is possible to notice that till 2040 electrical energy generated by renewable sources will be the world's largest source of electrical energy [2].

Figure 1 shows constant growth of the world electrical energy consumption which was provided by Global Energy Statistical Yearbook [3].

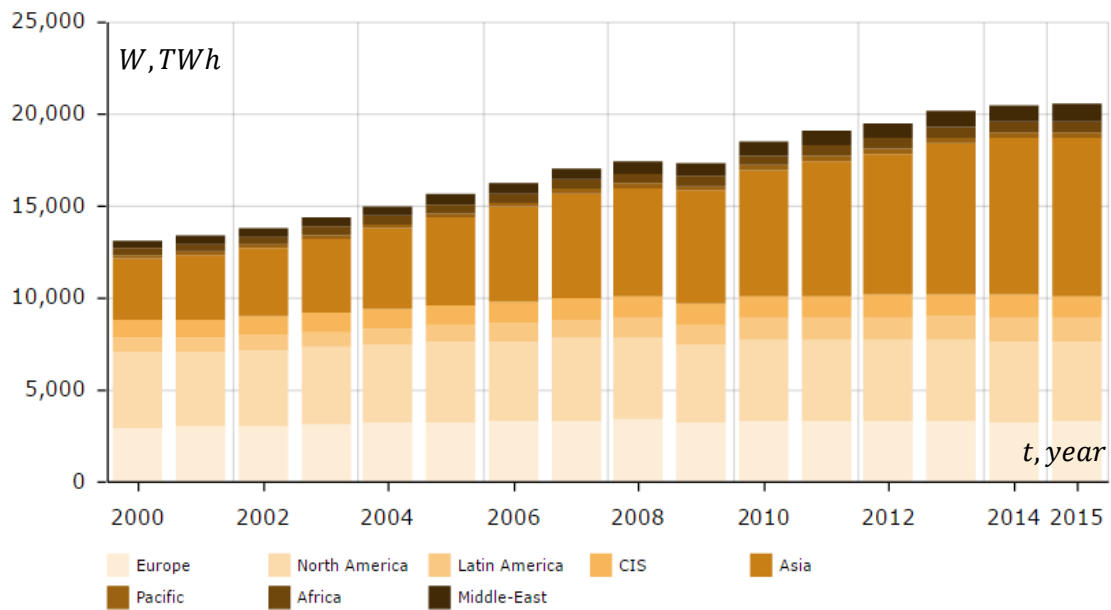

Figure 1 - World electrical energy consumption [3]

The electrical energy use in the world is rising significantly due to increasing energy consumption, the growing of population, constantly developing society, the rapid growth of modern technologies and ext. The figure 1 shows world electricity consumption. There is constantly growing dynamic and it is simply to notice that from 2000 till 2015 electrical energy consumption increased significantly. All these factors lead modern world to invent measures, which from one hand will allow to decrease level of energy consumption and energy generation and from another hand to reduce cost of the energy. There is a necessity of reducing energy consumption since it could lead to irrational resources use. Irrational energy consumption can lead not only to bad influence on business running but as well to irreversible environmental consequences [3].

1.2 Energy efficiency concept

Analyzing the existing situation of the rapid worldwide energy growth rate, it is possible to say that there is a necessity in implementation measures which will allow to contribute reduction of energy consumption level.

Energy saving methods mean controlling and reducing organization's energy consumption. Exactly these factors are important because it can lead to:

- Cost reduction – due to the fact of cost increasing this is becoming significantly important.
- Carbon emissions reduction and caused by it environmental damage - as well as the cost-related implications of carbon taxes.
- Risk reduction – the more energy is consumed, the greater the risk that energy price increases or supply shortages could seriously affect on company. With energy management this risk can be eliminated by reducing demand for energy and by controlling it so as to make it more predictable [4].

One of the most important factors is that the energy saving program should be applied to all buildings or to a group of buildings in such case the output of this program will be observed because only one

unit will not allow to have preferable result. The big role in this field plays scale of energy saving measures implementation.

Nowadays energy efficiency notion is lying in the basis of energy saving concept. To be energy efficient means to use less energy for the same amount of work. The example provided below shows a clear explanation of the notion to be energy efficient. For instance, there is a good insulated house. That house keeps heat better, therefore, less heat needs to be used for creation of comfortable environment in the house. This example shows what does it mean to be energy efficient. However, energy efficiency can be achieved in different ways. Firstly, existing buildings can be insulated by using of up-to-date insulation materials. Another opportunity is windows replacement with implementation of new three-glazed windows which eliminate heat losses. The next opportunity could be applied to industrial buildings. By using modern technologies there is a possibility to reuse heat which is produced during technological process and such heat can be used again in the industrial purposes [4].

Before the development of energy efficiency program, it is a necessary to know the current energy efficiency situation in the country. Because exactly this information is lying in the basis of energy efficiency program. Such basic information includes the existing level of energy efficiency implementation in a country, possible support from the government side and potential obstacles on a way of energy efficiency measures implementation. As an example of energy efficiency program implementation in Czech Republic is considered bellow.

1.3 The existing situation of energy efficiency implementation in Czech Republic

In the European Union (EU) all questions concerned energy savings and energy efficiency are regulated by Energy Efficiency Directive (EED). As Czech Republic is a part of the EU then the country have to perform all requirements of EED.

In 2012 EED stayed a target according to which all countries in EU till 2020 are required to design energy efficiency measures leading to 20% of efficiency. According to EED, that measures should be implemented on all levels of electrical energy using, from generation till end-user consumption. The Czech Republic is not an exception from these rules as well [5].

The requirements of the Directive were fully implemented into the Czech Republic law in 2015. During this time in the Czech Republic the following laws were passed: Act n. 406/2000 Coll., on Energy Management, Act n. 458/2000 Coll., on business conditions and public administration in the energy sectors and Act n. 165/2012 Coll., on subsidized energy sources. Based on that acts of laws, it is not difficult to notice that during relatively short period of time government of Czech Republic has started to work properly in the field of energy efficiency. Moreover, already in this field good results were reached [5].

In the Czech Republic energy efficiency measures have been developed according to requirements of the Directive throughout the whole energy chain but for us it is more interesting to know what measures were implemented to increase level of building energy efficiency and what results were achieved.

Energy efficiency measures implementation into the buildings shows a positive effect on the Czech Republic economy. Invested one billion of Czech Crowns (CZK) by state in energy efficiency programs realization can generate about 0,97 to 1,21 billion CZK back. At the same time energy efficiency measures implementation has a positive effect on GDP. Thus, according to the analysis provided in

the fourth report "On progress achieved towards meeting national energy efficiency targets in the Czech Republic" GDP value grows from 2,3 to 3,59 billion CZK [6].

The following results were achieved in the buildings of the Czech Republic:

- energy savings on heating for residential buildings are 77 PJ with medium-sized energy savings reconstruction (45% of original consumption) and 140 PJ with full reconstruction of heating system (81% of the original consumption);
- energy savings on heating of hot water are 12 PJ (about 30% of original consumption);
- energy savings for artificial lighting are 3,4 PJ (about 60% of original consumption) [6].

Energy efficiency situation in the Czech Republic is constantly developing and the figures mentioned above is a proof of it. The Czech Republic government provides support, which contributes to energy efficiency level improving.

2. Analysis of currently implemented energy efficiency measures in Russian Federation

In comparison with Czech Republic the basis of energy efficiency concept implementation is developed not so precisely. However, in Russian Federation some laws and measures in the field of energy efficiency were passed as well. The main reason for development energy efficiency measures was growth of expenses for energy needs in public buildings in Russian budget on approximately 5 % annually. This fact lies in the basis of development act of laws supporting energy efficiency measured implementation.

2.1 Description of passed law to increase energy efficiency level

The Federal law from 23.11.2009 N 261-FZ (edited 13.07.2015) "About energy savings and increase of electrical energy efficiency and about amendments in certain legislative acts of Russian Federation" regulates energy efficiency measures in Russian Federation. The main reason for development of this law was the growth of expenses for energy needs of public buildings in Russian budget on approximately 5 % annually. According to the law every public building has to develop an energy efficiency program which includes detailed energy efficiency and electrical energy saving measures plan implementation. Totally during next five years energy consumption in public buildings has to be reduced on 15%. That law has some drawbacks. Firstly, it does not include industry buildings where the rate of electrical energy consumption is much higher in comparison with residential buildings. Secondly, there is only one rate of estimation which does not take into account current building's condition and current energy efficiency class. However, the required result has not been achieved during required time and government introduced changes. According to the accepted assumptions the result have to be achieved till 2020, therefore, still there is a necessity in implementation of energy efficiency measures into public buildings [1].

2.2 Description of achieved results after implementation of the law

During energy efficiency program realization, mostly standard measures were used. As well there are some difficulties in estimation of achieved effect from applied measures because in the law there is no any accepted values according to which we can make a conclusion about energy efficiency of the building.

Possible omissions in the law:

- There is no motivation for people working in public buildings to reduce level of energy consumption because mostly financing of such buildings is provided by the state.
- As a consequence, only small amount of such buildings has a special staff which is responsible for energy consumption.
- For detailed and precise calculations, initial data play a significant role. However, for gathering such data it is necessary to implement energy management and monitoring devices. It is very difficult to get initial data for work because nobody measured it because there is no person who is responsible for it [7].

However, the main omissions were taken into account and till the present day it is possible to observe some results from energy efficiency measures implementation. According to the information,

reported in the government program, metering devices were installed. These devices allow measuring of consumed electrical energy, heating and consumed water in public buildings. Obligatory energy consumption examination of public buildings was implemented. As the main result number of primary energy consumption is reported. At the end of 2016 annual saving of primary energy source is 10,97 million tons of fuel equivalent or total saving of primal energy source from 2011 till 2015 is 39,56 million tons of fuel equivalent. According to the analysis proved in the government program during the period 2011 till 2016 Russian Federation saved 3 437,14 billion rub from fuel and energy sources purchasing. That number assumes that in the field of electrical energy 451,3 billion rub were saved [8].

Thus, there is place for energy efficiency growth and it is a good idea to look how the same components of energy efficiency program are used in another countries and what effects could be finally observed. To compare the existing situation in both countries it is possible to notice that energy saving measures implementation works in the Czech Republic much more better. The government created laws according to which energy efficiency technologies are used. These technologies allow to reduce level of energy consumption on significant rate and use energy in rational way.

Analyzing the existing situation and compare it with the situation in EU, in my work I would like to consider possible measures which can help to increase energy efficiency level in Russian Federation. In fact, most of them are limited due to fact that current conditions of the public buildings are very poor. But nevertheless, measures can be applied and I can estimate the output from these measures.

3. Analysis of energy consumption and description of given public building conditions

First of all, it is necessary to identify current conditions of the object of research. I will offer possible energy saving measures based on the building description and energy consumption analysis.

3.1 General description of the subject of research

The subject of my work is Tomsk polytechnic university educational building number eight.

The building is located on Usova 7 street, Tomsk. The location of educational building is provided on the Figure 2.

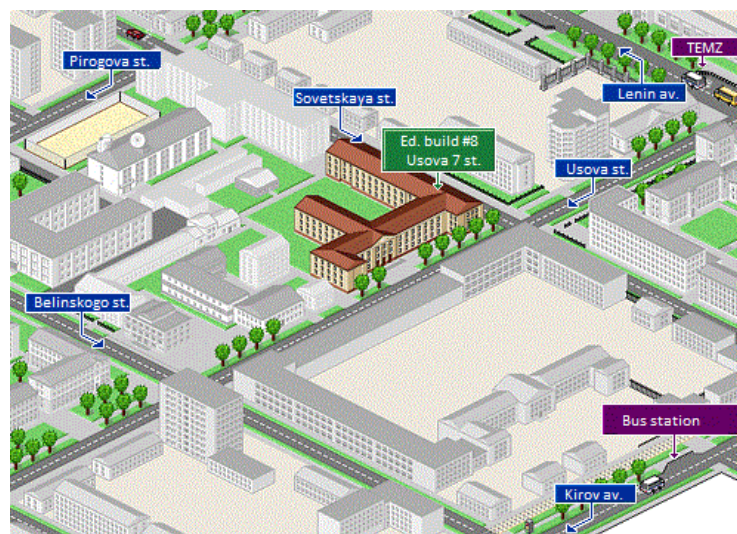

Figure 2 - Educational building location [15]

The building has four levels: ground floor, the first floor, the second floor and the third floor. Each level has the same plan. The plan of the second floor is provided in Appendix 1. Mainly the building has small rooms for practice classes. I analyzed structure of the building and concluded that all rooms in educational building can be divided into four main categories: lecture rooms, small practice rooms, teacher rooms and corridors. Figure 3 shows the educational building rooms subdivision.

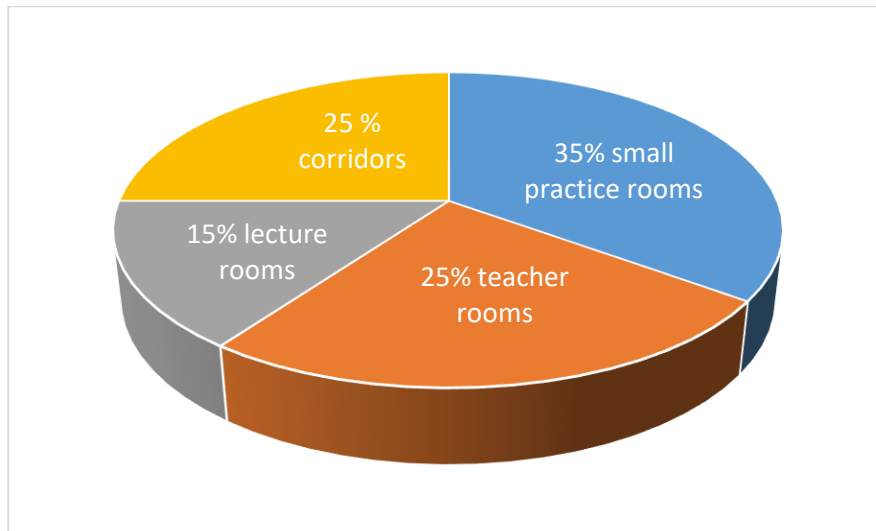

Figure 3 - Structure of educational building rooms

As Figure 3 shows the main part of educational building are small practice rooms (about 35%). That means that for every type of room special measures have to be created.

One more important factor, which has significant influence on electrical energy consumption, is climate conditions. Tomsk is located in variable climate zone. There is a continental climate. It is possible to notice that seasons in Tomsk region are changed rapidly, the winter period starts in November and lasts till April. The summer in Tomsk is short and tepid. The average temperature in January is $-22,6\text{ }^{\circ}\text{C}$, the average temperature in July is $+20,4\text{ }^{\circ}\text{C}$ [9].

The structure of educational process is provided in Appendix 2. According to the table the educational process is going constantly from September till July. Classes are conducted from Monday till Saturday (6 days per a week) from 08:00 till 20:00 (12 hours per a day).

What concerns electrical energy supply, the building is powered by two substations. In Appendix 3 a part of single line scheme of TP-671-2 and TP-671-2a substations is represented. The scheme shows the external power supply of educational building. Substations TS 671-2 and TS 671-2a have installed capacity of consumers $P_{inst}=650\text{ kW}$. There are seven incoming switchgears in educational building. Installed capacity of educational building consumers is 650 kW [10].

3.2 Analysis of energy consumption by considered educational building

An analysis of energy consumption by Tomsk polytechnic university educational building is provided bellow.

In the table 1 energy consumption data by Tomsk polytechnic university educational building is represented. These data were obtained by counters which are installed in an incoming switchgear.

Table 1 - Thermal and electrical energy consumption data for 8 years period [5]

	2007	2008	2009	2010	2011	2012	2013	2014
Electrical energy consumption, MWh	548,3	559	823	821,4	799,3	559,3	599	579
Thermal energy consumption, Gcal	3850,7	4087,4	3863,4	3741,4	2768,3	NA	NA	NA

To have a clear possibility to compare these data I will convert it to the same units – Gcal to MWh (Table 2).

Thus, 1 Gcal=1,162 MWh.

Table 2 - Thermal and electrical energy consumption data in MWh units

	2007	2008	2009	2010	2011	2012	2013	2014
Electrical energy consumption, MWh	548,3	559	823	821,4	799,3	559,3	599	579
Thermal energy consumption, MWh	4474,6	4750	4489,7	4347,9	3217	NA	NA	NA

Figure 4 shows the dynamic of energy consumption by the Tomsk polytechnic educational building.

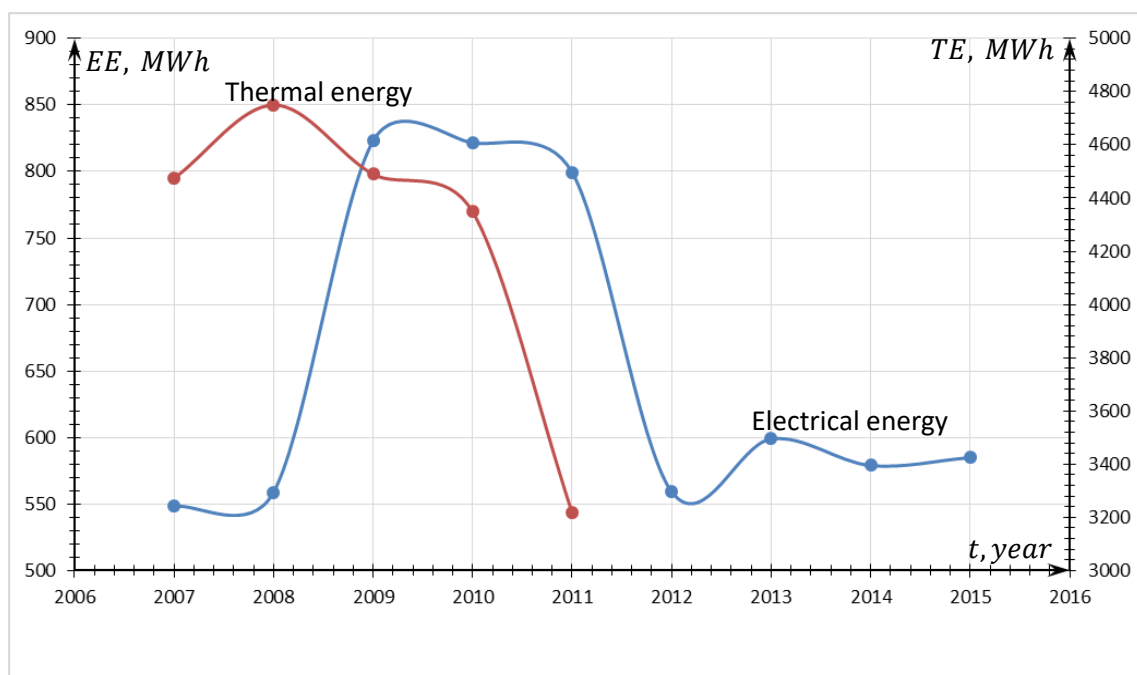

Figure 4 - Energy consumption dynamic [11]

Analyzing the Figure 4 I can conclude that there is a tendency of thermal energy consumption reduction. This reduction could be a result of changing a part of old windows to new windows, which have better insulation against loss of heat, another reason could be regulation of the heating and artificial reducing of heating season as well.

What concerns electrical energy consumption, during the period from 2009 till 2011 there was a leap in electrical energy consumption. However, from 2011 electrical energy consumption started to reduce and currently it is approximately at the same level. This reduction can be explained by implementation of energy efficiency measures.

During electrical energy analysis there is a necessity to take into account electrical energy prices since it is known that electrical energy tariff grows every year. Bellow dynamic of electrical energy prices is represented [12].

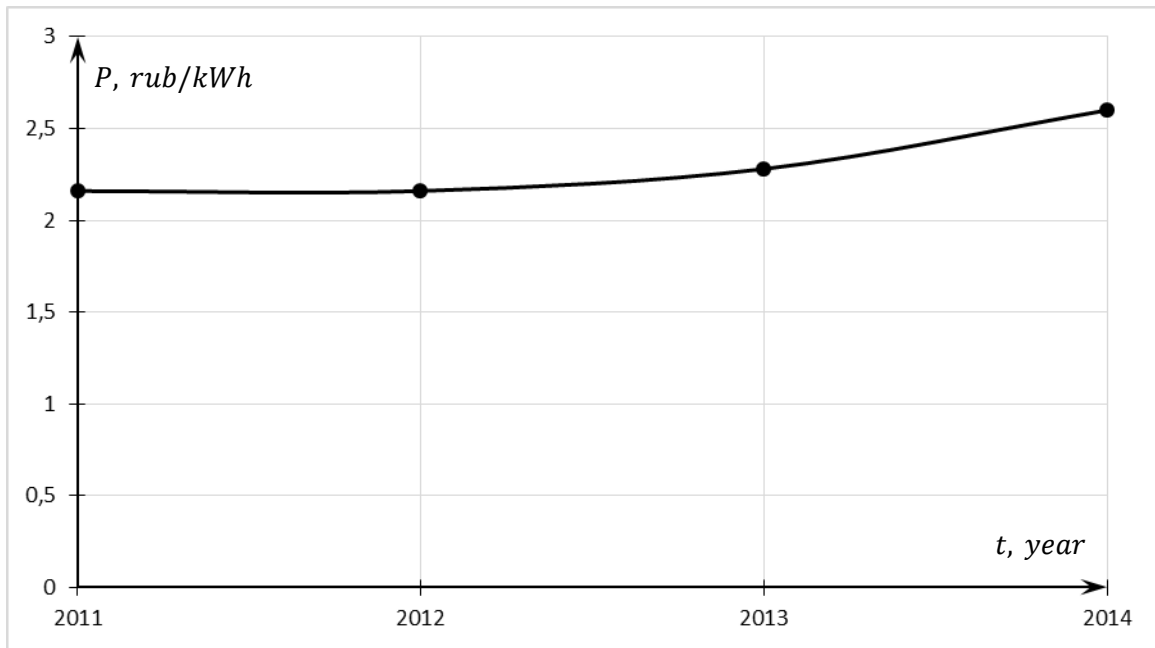

Figure 5 - Electrical energy price changing dynamic

If take into account changing of electrical energy consumption by educational building then the payment change the following way (Figure 6).

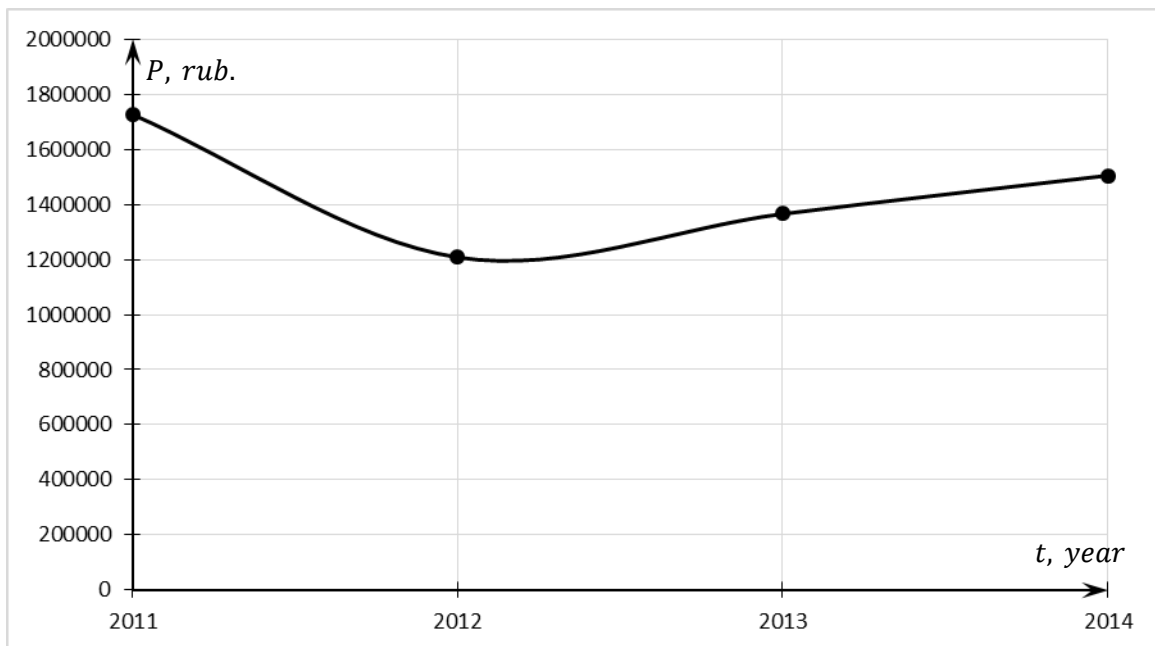

Figure 6 - Electrical energy payment changing dynamic

Figure 6 shows that in 2012 a small decrease of electrical energy consumption was observed and consequently the payment for electrical energy was less, moreover, the electrical energy tariff during 2011-2012 was at the same level. From 2012 electrical energy consumption was approximately stable but the slow tariff growth increased payment for electrical energy.

3.3 Analysis of factors which influence on electrical energy consumption

The organization of educational process mainly influence on electrical energy consumption in educational buildings. Taking into account an influence of linear schedule (Appendix 2) of educational process could help to show the structure of electrical energy consumption more precisely and increase the accuracy of electrical energy consumption forecast.

The linear schedule of educational process shows that the educational process goes continuously during an academic year. Thus, lecture rooms are always demanded and changing of educational process is impossible.

Taking into account the number of students, which was reached in statistical documents [13], I can evaluate specific electrical energy consumption for one student. In Table 3 the number of power engineering institute students is represented.

Table 3 - Power engineering institute students number

Year	2007	2008	2009	2010	2011	2012
Number of students, pers.	2 168	2 094	2 099	2 313	2 171	2 098

The numbers in the table show that the quantity of students is changed not significantly due to this fact I can conclude that quantity of students doesn't influence on electric energy consumption.

Another factor, which has influence on electrical energy consumption rate, is duration of daylight. Daylight duration in autumn and spring is more than in winter therefore lighting installations are used more actively during this time. During winter there is bigger electrical energy consumption rate [14].

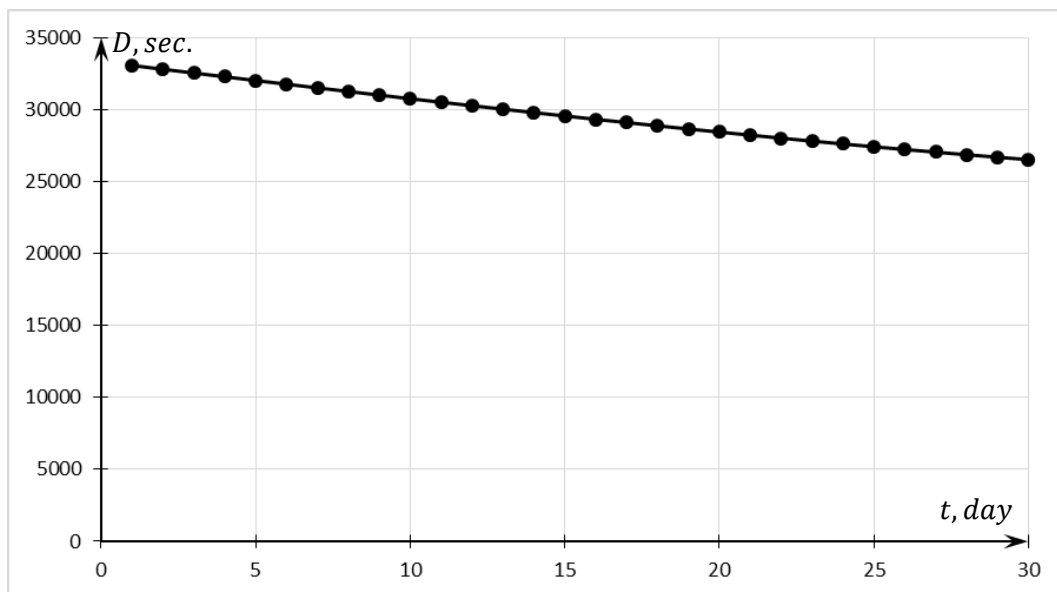

Figure 7 - Daylight duration change in November [14]

Of course, daylight duration time is one of the most important factors which have influence on electrical energy consumption rate.

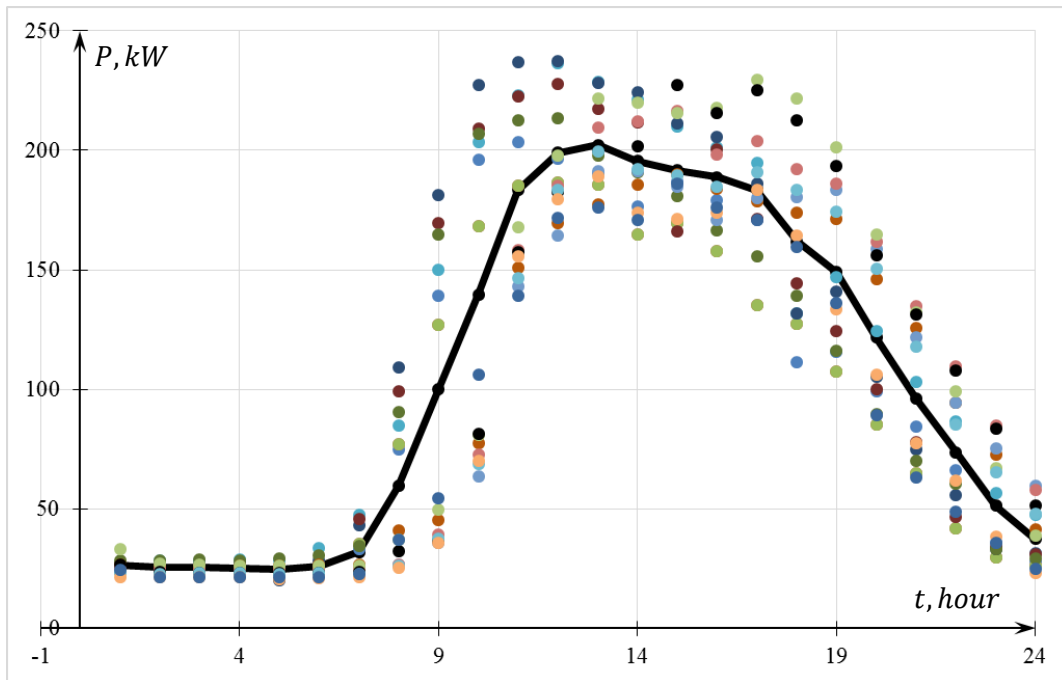

Figure 8 - Average electrical energy consumption for working day in November [11]

Figure 8 shows that the maximum of electrical energy consumption is from 11:00 till 20:00. In this case using of motion sensors and automatic control system will allow to decrease electrical energy consumption rate.

Let's take into account the average daily temperature change in November.

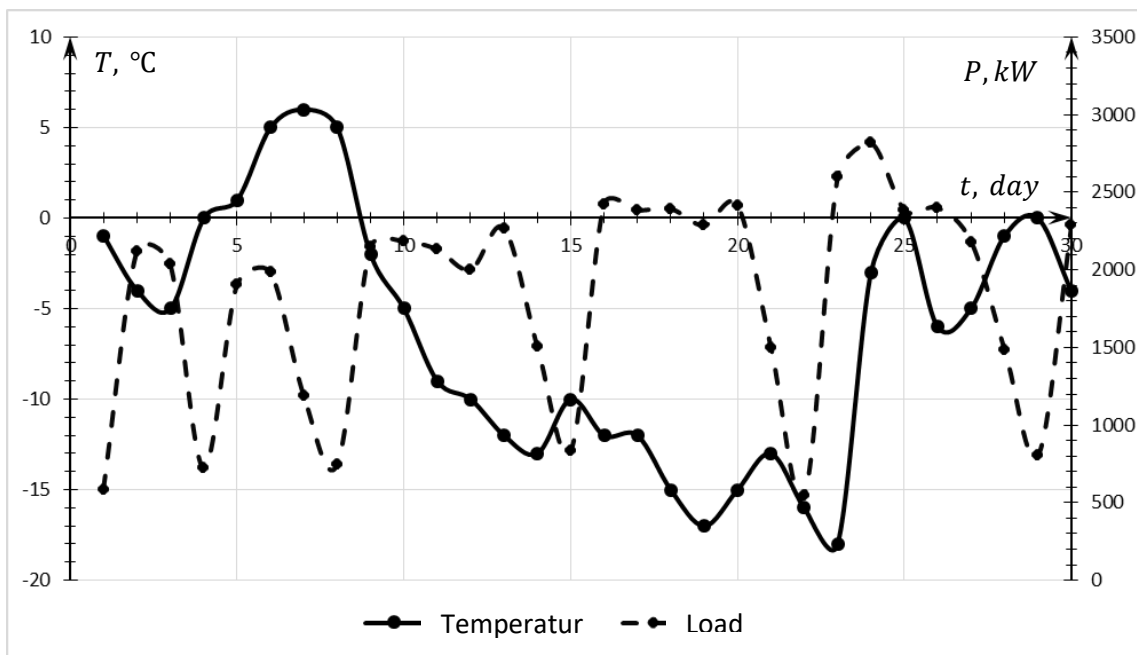

Figure 9 - Average daily temperature and electrical energy consumption change in November 2015 [11]

From the 10th till the 24th of November the temperature is below zero, therefore during this period electrical energy consumption was bigger in comparison with other days of this month. Decreasing of electrical energy consumption can be explained by season character of electrical energy consumption. Figure 9 shows that during working days when there is decrease of temperature the

electrical energy consumption is increased and in the opposite when there is temperature increase the electrical energy consumption rate is decreased [15].

3.4 The main electrical energy consumers in educational building

The main electrical energy consumers in educational building are lighting installations, office mechanization facilities and laboratory equipment. The structure of electrical energy consumption is presented in Figure 10 [Appendix 1].

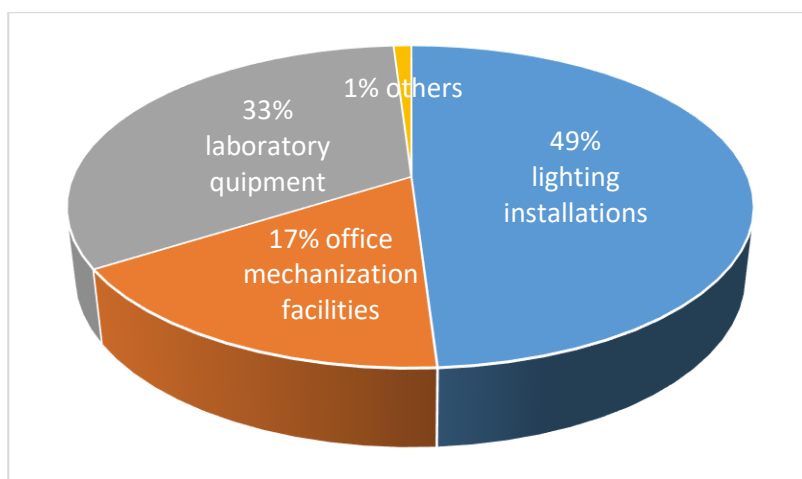

Figure 10 - Structure of electrical energy consumption in educational building

The part of consumed electrical energy by lighting installations is about 49% in educational buildings. According to statistical data electrical energy consumption by Tomsk polytechnic university in 2014 is 578 920 kWh [8]. Saving of electrical energy in lighting system can be achieved as by decreasing nominal power of lighting sources as by reduction of usage period of lighting installations and by implementing automatic control system.

As Figure 3 shows the main part of educational building are lecture rooms and research laboratories which have strict requirements to lighting level. Nowadays the level of artificial lighting in lecture rooms mostly does not satisfy the minimal lighting requirements according to normative documents [16]. There is a necessity in lighting system reconstruction to satisfy requirements of FZ-261 [1]. The reconstruction will allow to reduce expenses on electrical energy by realization energy saving measures and it will allow to reach required lighting level.

The core measures in electrical energy saving in lighting installations are the following:

- Reduction of incandescent lamps usage and changing it for fluorescent lamps. Another variant is changing fluorescent lamps for LED.
- Usage fluorescent lamps with higher light output.
- Implementation of energy efficient fluorescent lamps: 18W instead of 20W; 36W instead of 40 W; 58W instead of 65W.
- Efficiency rate increasing of existing light sources by regular cleaning.
- Usage of reflected light
- Implementation of automatic control system [17].

4. Identifying and designing of suitable energy savings measures for considered public building

Government can make a significant influence on reducing of energy consumption by developing special laws. It is necessary to notice that government is interested in it because such measures show that technologies in the country are developing and the country is going further. Thus, I can say that government support plays a big role in stimulating of energy efficiency measures implementation.

According to Figure 10 the significant part of electrical energy consumption in educational buildings is consumption of electrical energy by lighting installations. Analyzing it there is a possibility to influence on lighting installation and reduce power consumption. However, such measure demands relatively big investments. What concerns another electrical energy consumers in educational building their part is not so big but nevertheless I can create measures to regulate it as well. Thus, like initial data with that I can operate are following: data about electrical energy consumption, general data about building (size, quantity and type of rooms, availability of different technologies), data about heating, data about the source of hot water, system of rooms air conditioning and ext.

4.1 Possible energy efficiency measures

Nowadays development of energy efficiency measures assigns more and more popular direction. There are different papers written by different authors throughout the world where is described tries and experience of energy efficiency measures implementation in this field depending on different climate conditions and various types of buildings.

Such measures I can distinguish into two categories depending on investments (Figure 11).

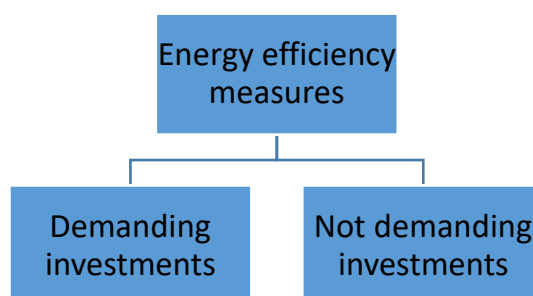

Figure 11 - Primary categories of energy efficiency measures

For development energy efficiency measures which do not require investments careful analysis of existing situation in the building has to be provided. It is important to know what technologies are used currently in the building and possible ways of influence on them. An example of such measures can be upgrading of heating system, upgrading of ventilation system and any other systems which are used in the building. During detailed analysis of electrical energy consumption “weak places” can be revealed in the building, the places where there are energy losses or energy is used inefficiently. In case of measures which are demanding investments detailed economical evaluation has to be provided along with it there is a necessity to find the source of investments. Such measures include replacing lighting installations, development of control system, replacement of energy source to more efficient one and etc. [18].

Depending on the way of implementation all measures can be divided into following five groups [19].

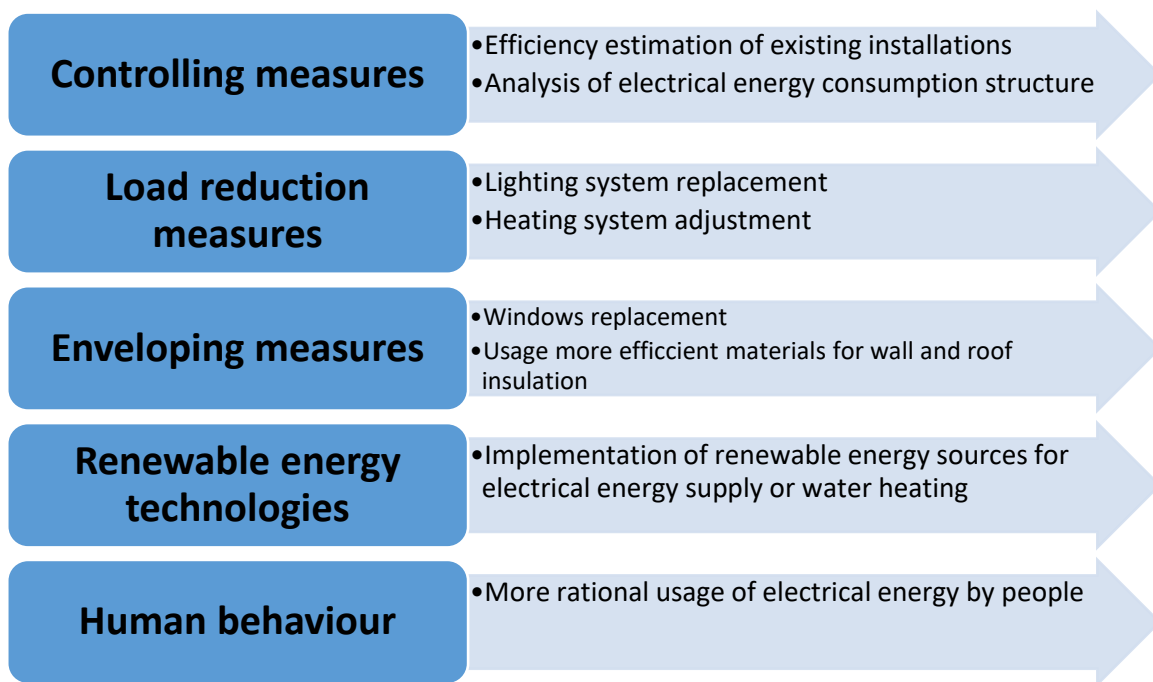

Figure 12 - Core ways of energy efficiency measure implementation

Using controlling measures, I can follow and monitor the information about primary consumption level and estimate efficiency of existing installations. Load reductions measures mean adjustment of existing technologies in the building. For example, I can attribute in this group lighting system replacement or heating system adjustment. Enveloping measures include using more efficient materials for walls and roof insulation. Moreover, the example of such measures can be windows replacement by more efficient models. Many authors recommend using of renewable energy sources, however, such measure can be applied not for all types of buildings. Finally, the last category is human behavior. This measure offers development of stimulus for people to use electrical energy less or to use energy more rationally [19].

Unfortunately, not all from offered ways of energy efficiency measures implementation can be used for my object of research. First of all, I should take into account type of the building. Such measures as enveloping, renewable energy technologies or human behavior will work in an efficient way in residential buildings, where the building has relatively small square and users are interested in energy consumption reduction.

In case of public building such measures as controlling and load reduction can be implemented and it is expected that it will bring a good result. As well in frame of public buildings enveloping measures can be applied, however, such measures will be more expensive and additional estimation of investment efficiency should be provided. In my work, I will use two approaches. I will analyze EE consumption in detail trying to distinguish possible ways of electrical energy consumption reduction without any investments and the second measure will be implementation of measures which allow using of electrical and thermal energy in more rational way.

4.2 Analysis of electrical energy consumption structure

How it has been considered before electrical energy consumption rate depends on many factors. In this chapter I want to analyze the structure of electrical energy consumption. To distinguish possible ways how I can influence on this rate.

According to Figure 4 during the period 2012-2015 electrical energy consumption is not changed significantly, therefore, as a basic year I will consider 2014. On this stage it is necessary to normalize electrical energy consumption and distinguish it's structure.

Figure 13 shows EE consumption for each month during 2014.

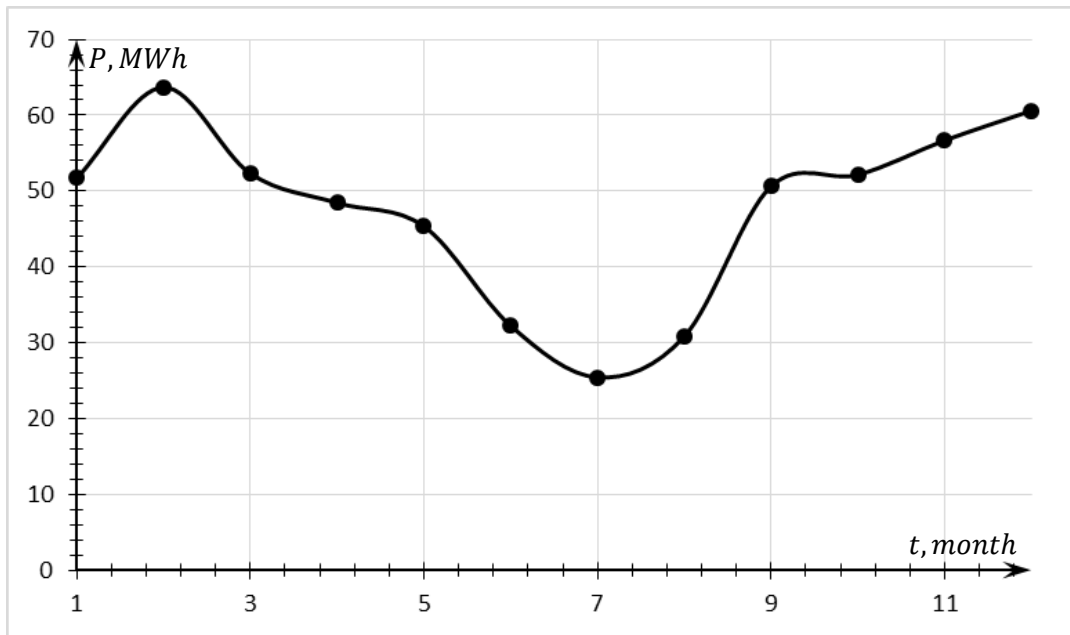

Figure 13 - Electrical energy consumption during 2014 year [11]

During winter time EE consumption rate is higher. It can be explained by the duration of lighting day, outside temperature, educational process. In summer EE consumption is lower, it is obtained due to the fact that during that time there is no classes for students. During transitional seasons (autumn, spring) EE consumption rate differs on winter because daylight duration and outside temperature is higher.

Bellow monthly EE consumption for each season is provided.

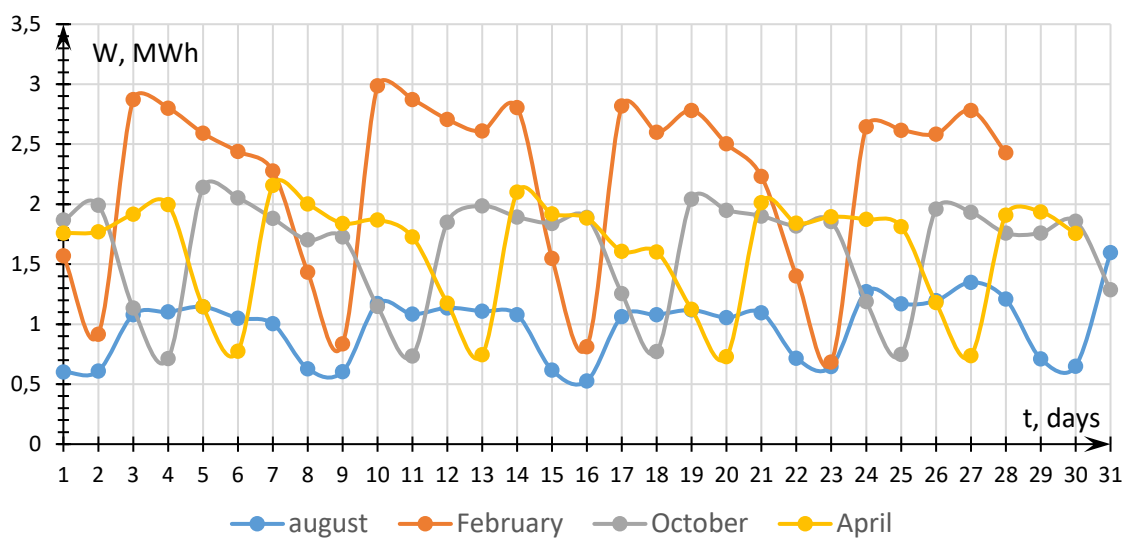

Figure 14 - Electrical energy for each season [11]

As it is possible to see that during summer and winter electrical energy consumption level differs significantly. However, during autumn and spring it is almost on the same level. Below in the Table 4 data about average electrical energy consumption for each period are provided.

Table 4 - Average installed power for every season [11]

Period	Winter	Spring	Summer	Autumn
	1	2	3	4
Semi-peak, P kW	99	73	43	78
Peak, P kW	203	155	86	149
Night, P kW	31	24	19	24

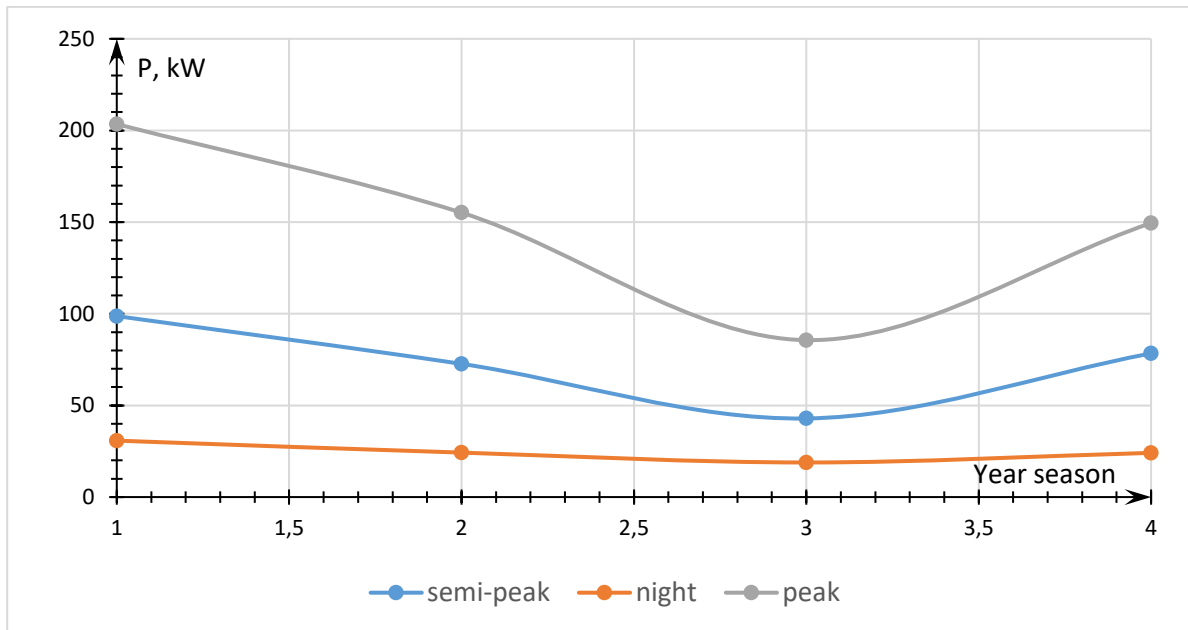

Figure 15 - Average installed power for every season [11]

Figure 15 shows average installed power for specific parts of a day (semi-peak, peak and night) for every season, during night load almost the same for each season. Thus, I can conclude that basic load in the educational building which almost does not depend on any factors is about 23 kW. However, power load during peak time differs significantly. I would like to notice the fact that during two summer months there are no classes in the building and the lighting installations and heating system are not used. Thus, I can assume that peak load during summer (86 kW) is a load which does not include lighting installations and local heating installations.

However, power load in peak period differs from autumn, spring and winter. It can be explained by the fact of low temperature outside and short lighting day period duration.

4.2.1 Energy efficiency measures based on electrical energy consumption analysis

Thus, to distinguish structure of electrical energy consumption I will consider summer and winter EE consumption during a day in details.

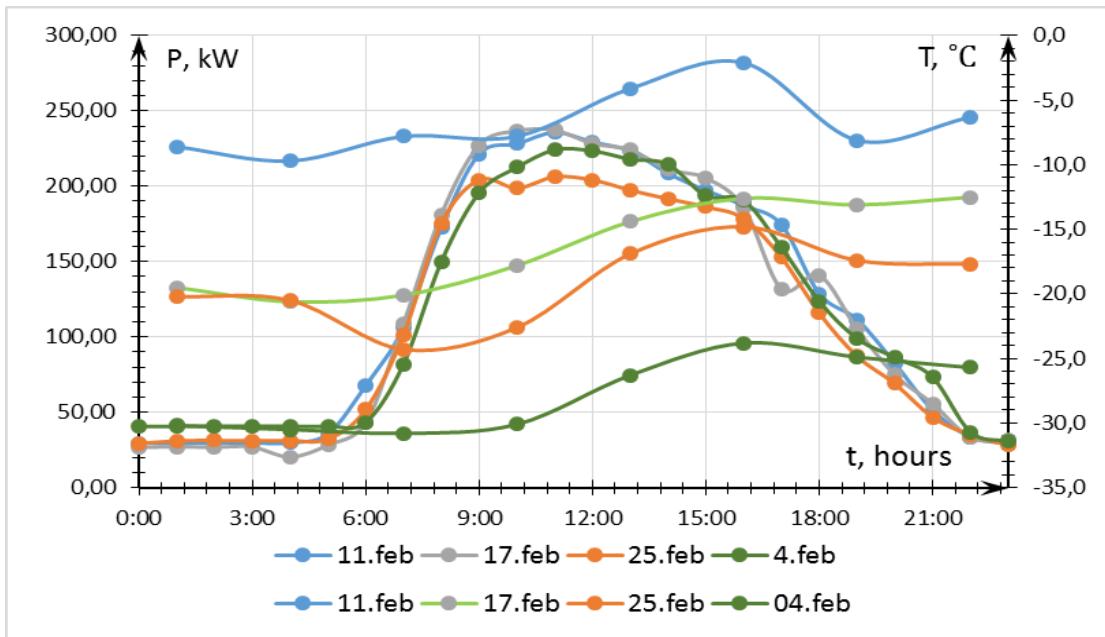

Figure 16 - EE consumption during a day in winter depending on outside temperature [11]

In winter, electrical energy consumption rate almost is not changed with the temperature changing because in winter outside temperature is always below zero. However, I can notice (Figure 16) that in winter electrical energy consumption is on the same level.

Let's consider the situation with EE consumption during September month. I have chosen this month because the building operates in its ordinary mode, however, temperature outside is above zero and I can equal this weather conditions to summer weather conditions. In fact, EE consumption rate depends on outside temperature changing. Below the graph is represented which shows EE consumption depending on outside weather for the warmest and the coldest day in September.

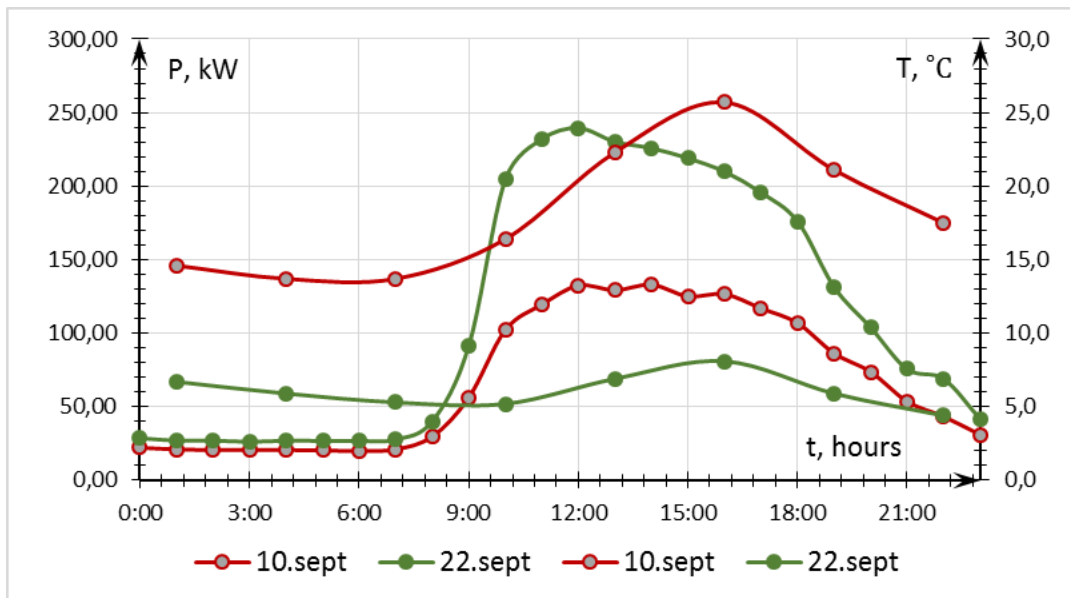

Figure 17 - EE consumption during a day in September depending on outside temperature [11]

As we can notice electrical energy consumption depends on weather conditions. The graph shows that when the temperature outside is lower the electrical energy consumption rate is higher. Due to

this fact, I can assume that the part of the difference in electrical energy consumption is used for heating. Commonly in small rooms, where people work, they use local heaters to create comfortable conditions for work. The graph below shows average EE consumption in February and September.

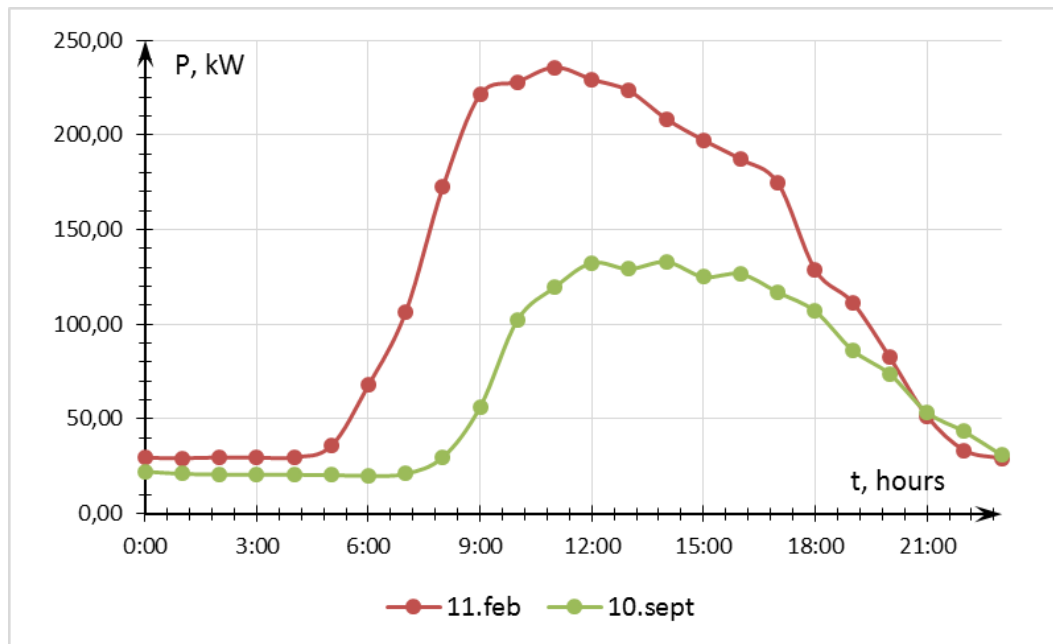

Figure 18 - Average electrical energy consumption in February and September days [11]

I can assume that a part of the difference in electrical energy consumption is used for local heaters, however, I should take into account the difference in lighting day duration [14] and other additional needs during winter. During my calculation I took into account that the duration of lighting day in February is 9 h. 15 min. and in September is 13 h. 15 min. Therefore, a part of energy is used for lighting installations during winter period.

As it was mentioned before the part of lighting load is 49% [20] then the load excluding lighting load for 00:00 in February

$$P_{wL} = P - P_{lighting}$$

$$P_{wL} = P - 0,49 \cdot P = 29,55 - 0,49 \cdot 29,55 = 15,07 \text{ kW}$$

Where:

P – installed power load, kW;

$P_{lighting}$ – power of lighting installations, kW.

In the same way the load is calculated for every hour.

Let's assume that heaters are used only during working hours and to minimize a mistake since the difference in electrical energy consumption is used not only for local heaters but as well for other needs I introduced a coefficient $k=0,6$ which is based on empirical observations. Then power consumed by local heaters will be calculated in the following way:

$$P_{LH} = P_{dif} \cdot k$$

$$P_{LH} = 72,8 \cdot 0,6 = 43,68 \text{ kW}$$

Where:

P_{dif} – difference in load in February and September, kW;

Table 5 - Electrical energy consumption for average day in February and September [11]

Time	11.02.2014		10.09.2014		Difference in consumption	
	P , kW	P_{wL} , kW	P , kW	P_{wL} , kW	P_{dif} , kW	P_{LH} , kW
0:00	29,55	15,07	22,24	11,34	3,73	
1:00	29,25	14,92	21,01	10,72	4,20	
2:00	29,70	15,15	20,67	10,54	4,60	
3:00	29,62	15,11	20,52	10,47	4,64	
4:00	29,78	15,19	20,56	10,49	4,70	
5:00	35,72	18,22	20,36	10,38	7,83	
6:00	67,79	34,57	19,92	10,16	24,41	
7:00	106,36	54,24	21,04	10,73	43,51	
8:00	172,52	87,98	29,77	15,18	72,80	43,68
9:00	221,44	112,94	56,30	28,71	84,22	50,53
10:00	228,16	116,36	102,16	52,10	64,26	38,55
11:00	235,80	120,26	119,52	60,96	59,30	35,58
12:00	229,46	117,02	132,42	67,54	49,49	29,69
13:00	223,39	113,93	129,24	65,91	48,02	28,81
14:00	208,57	106,37	133,01	67,84	38,53	23,12
15:00	197,30	100,62	125,06	63,78	36,84	22,11
16:00	187,24	95,49	126,62	64,58	30,92	18,55
17:00	174,54	89,02	116,89	59,61	29,40	17,64
18:00	128,79	65,68	106,91	54,52	11,16	6,69
19:00	111,63	56,93	86,39	44,06	12,87	7,72
20:00	82,57	42,11	73,74	37,61	4,51	
21:00	51,54	26,28	53,57	27,32	-1,03	
22:00	43,55	22,21	43,33	22,10	0,11	
23:00	29,19	14,89	30,98	15,80	-0,91	

According to calculations provided above every working day local heaters consume about 323 kWh of electrical energy (sum of the last column). It is possible to create measures which will eliminate usage of local heaters and, consequently, reduce electrical energy consumption rate.

4.2.2 Elimination of irrational electrical energy consumption rate

Usage of local heaters in public buildings is not common and this means that significant amount of EE is consumed irrationally. Because of this there is a possibility to create such measures that will restrict usage of local heaters.

First of all, special lectures can be provided which will influence on people behavior. However, there is another way which will allow to control behavior of people concerning local heaters usage. Such measure includes implementation of circuit breakers for rooms where people works during significant time. For every such room depending on quantity of electrical consumers average consumed energy should be calculated. For example, for teacher room which has square 50 m² there are 10 working places. Taking into account that the main electrical energy consumers in the teacher room are computers, printer and lighting installations then the installed power of a teaching room is

about 5 kW (power of a computer is 250 W, printer – 2 kW, lighting installation – 576 W) then for such room I should select a circuit breaker with nominal power 5,5 kW (25A) [21].

Thus, analysis of electrical energy consumption structure reveals that 323 kWh per a day is consumed irrationally. By influencing on people behavior, it is possible to reduce this electrical energy consumption rate and implementation of circuit breakers for rooms where people works during significant time will allow controlling of local heaters usage restriction.

4.3 Analysis of enveloping measures implementation

During EE structure analysis usage of local heaters was revealed. This means that inside temperature in educational building is not enough for comfortable work of people. Moreover, at the same stage with restriction of local heaters usage I should design additional measures for comfortable work of people.

Firstly, in this case it is possible to increase the level of heating supply. In fact, for producing 1 Gcal of energy local heaters consume more electrical energy than if that energy would be supplied by central heating supplier. If I consider the building in the current condition without implementation of any measures which will allow to save heating inside of the building, then the result will be following. During heating period, local heaters consume 32 270 kWh of energy, this amount of energy is equivalent to 28 Gcal. Thus, not to destroy comfortable conditions of work such measure allows eliminating of local heaters usage and increasing the level of consumed thermal energy.

As it was mentioned before rate of heat supply can be increased for comfortable work conditions. On the other hand, measures which will reduce heat losses in the building can be provided. Such measures include walls and roof insulation and windows replacement. Efficiency of such measures can be estimated by calculation of heat losses in specialised software. For estimation of heat losses in my work K-CAD software was used. As an initial data I need to know size of the building (square, volume), materials of walls and roof, quantity of windows and their parameters [22, 23]. I would like to notice that in the basis of calculation model of educational building lies, due to this fact calculated values of savings are roughly estimated based on expert guesses. Such rough estimations were done to evaluate whether there is a potential in building insulation.

I considered the following variants during calculation:

- **1.Variant:** Walls insulation by using polystyrene material (200 mm);
- **2.Variant:** Ceiling insulation by using mineral wool (400 mm);
- **3.Variant:** Windows replacement by new windows with triple glazing;
- **4.Variant:** Implementation of all measure described before

The result of calculation is provided in the Table 6

Table 6 - Results of heat insulation efficiency

Number of variant	Measure	Energy saving, %	Demanded heating, Gcal
Existing variant	-	-	2 678
1.Variant	Walls insulation	11,1	2 356
2.Variant	Ceiling insulation	26,9	1 938
3.Variant	Windows replacement	10,9	2 362
4.Variant	All measures	52,2	1 266

Thus, as it is possible to see from the table, implementation of all described measures will allow saving 52% of heat losses. However, each of such measures demands significant investments, therefore, I can make a conclusion about energy efficiency from these measures implementation only after economical evaluation of offered measures.

4.4 Energy efficiency measures based on controlling and load reduction

According to Figure 10 the biggest part of electrical energy consumers are lighting installations. Thus, it is possible to create measures, which will influence on electrical energy consumption by lighting installations. Such measures can include lighting system replacement in the rooms where there are strict requirements for lighting level. Another measure could be changing of start-control devices to electronic devices, for example, in corridors where lighting system replacement is not efficient. Taking into account this fact we can remain fluorescent lamps there and replace only start-control devices, which will consume less energy in comparison with the old one, however, such measure will not allow saving of significant amount of energy. Another possible measure includes dimmer usage. Dimmers will provide adjustment of lighting level brightness according to demand. The final variant includes installation of lighting control system which will provide necessary level of lighting or switching off the lighting when there is nobody in room as well such system provides different level of lighting in every part of room as it is known that the light flow is distributed in the room unevenly.

The next energy efficiency increasing measure is operation of heating installations. First of all, one of such measures can be adjustment of air temperature in the room to support required level in the room where constantly lessons are provided and to make the temperature less where it is possible. However, according to analysis provided in chapter 4.3 existing level of heating is not enough for comfortable work of people, therefore, level of heating can be reduced only after implementation of enveloping measures which are described in chapter 4.3.

The next possible measure is usage of electrical energy which is generated by renewable energy sources. There is a wind turbine in the yard of the building and solar panels on the building. To increase energy efficiency, I can evaluate a possibility of using electrical energy generated by renewable energy sources for educational building needs. For example, usage of this electrical energy for feeding outside lighting or lighting in corridors where there is not any strict requirement to lighting level [16].

During the analysis of existing situation of electrical energy consumption in educational building a solution about conducting the following measures was accepted. Effective way of electrical energy consumption reduction includes replacing old non-efficient lighting sources to new more energy efficient. Moreover, automatic control system will provide more rational consumption of electrical energy by lighting installations. From other hand, such action will lead to reduction of electrical energy consumption by lighting installations, increasing of lighting installations operational period, decreasing of payment for electrical energy consumption and decreasing of operational cost.

4.4.1 Lighting system reconstruction

Let's consider lighting system reconstruction in a lecture room. The existing lighting level is considered in a typical lecture room. Below is provided calculation of existing lighting level in current situation.

Room size:

- The height: $H=7$ m.
- The length: $A=16$ m.
- The width: $B=9$ m.
- Working surface height above the floor: $h_p = 0,8$ m.

Scheme of light sources arrangement in the considered lecture room is represented in Appendix 4.

Thus, in the lecture room there are 48 ODO lamp sets. Taking into account that in every lamp set there are four fluorescent lamps Philips Standart 18 W then the total number of light sources are $N=192$.

Calculation of general regular artificial lighting of horizontal surface is conducted by coefficient of light flow usage method which accounts as well light flow reflected from ceiling and walls [16].

The room index:

$$i = \frac{S}{H \cdot (A + B)} \quad (1)$$

$$i = \frac{144}{7 \cdot (9 + 16)} = 0,82$$

Where:

- S – square of illuminated room, m^2 ;
- A – length of the room, m ;
- B – width of the room, m ;
- H – height of the room, m .

Coefficients of ceiling and walls reflection are the following according to [16] $\rho_c = 70\%$ and $\rho_w = 50\%$.

Coefficients of light flow usage η , in frame of $\rho_c = 70\%$ and $\rho_w = 50\%$, $\eta = 45\%$ [16].

Calculation of required light flow in each of rows:

$$F = \frac{E_n \cdot S \cdot K_r \cdot Z}{N \cdot \eta} \quad (2)$$

$$F = \frac{300 \cdot 144 \cdot 1,5 \cdot 1,1}{192 \cdot 0,45} = 825 \text{ lm}$$

Where:

$E_n = 300$ lx – specified minimal illumination according to SNiP 23-05-95 (level of visual work IV, conducted visual work has average accuracy, the minimal object of distinction is in the diapason of 0,5-1,0; background characteristics – light, object contrast with the background is high), [16];

$S = 144 \text{ m}^2$ – area of illuminated room;

$K_r = 1,5$ – coefficient of reservation, which takes into account lamp contamination (lighting source, lighting accessories, walls and etc.), presence in atmosphere smoke and dust [16];

$Z = 1,1$ – coefficient of inequality of lighting, E_{av}/E_{min} . For fluorescent lamp the number is equaled 1.1 [16];

$N = 192$ – number of lamps;

$\eta = 45\%$ - coefficient of usage.

Table 7 shows technical parameters of existing Standart 18W fluoriscent lamps.

Table 7 - Technical parameters of Philips Standart 18W FL

Voltage, V	Power, W	Light flow, lm
220	18	1080

The main parameters for existing lighting installation are provided below:

Power of lighting installation:

$$P_{L.inst.} = N \cdot P_i \quad (3)$$

$$P_{L.inst.} = 192 \cdot 18 = 3,456 \text{ kW}$$

Where:

N – number of lamps;

P_i – installed power of a lamp, W.

Electrical energy consumed by lighting installation during a year:

To calculate this value I assumed that lighting installations are in operation during 10 hours per a day and 247 days per a year (a year includes 247 working days).

$$W = P_{L.inst.} \cdot T \cdot D \quad (4)$$

$$W = 3456 \cdot 10 \cdot 247 = 8\,536 \text{ kWh}$$

Where:

T – time during which lighting installations are in operation, hours;

D –quantity of working days per a year.

For rational designed lighting system following condition have to be satisfied:

$$0,9 \cdot E_n \leq E_{calc} \leq 1,2 \cdot E_n \quad (5)$$

$$E_{calc} = \frac{F \cdot N \cdot \eta}{S \cdot K_r \cdot Z} \quad (6)$$

$$E_{calc} = \frac{1080 \cdot 192 \cdot 0,45}{144 \cdot 1,5 \cdot 1,1} = 392,73 \text{ lx}$$

$$270 \leq 392,73 \leq 360$$

The condition is not satisfied, therefore, designed lighting system is not efficient. Actual lighting level is higher than it is required. This is connected with the fact that light flow is distributed unevenly because of the structure of the lecture room. At the end of the room lighting level is higher due to the fact that distance between lamps and tables decreases.

To evaluate life time period of fluorescent lamps I should analyze efficiency of lighting flow. It is known that during time of operation the efficiency of lighting sources output degrades. Below (Figure 19) graph shows characteristics of light flow degradation for fluorescent.

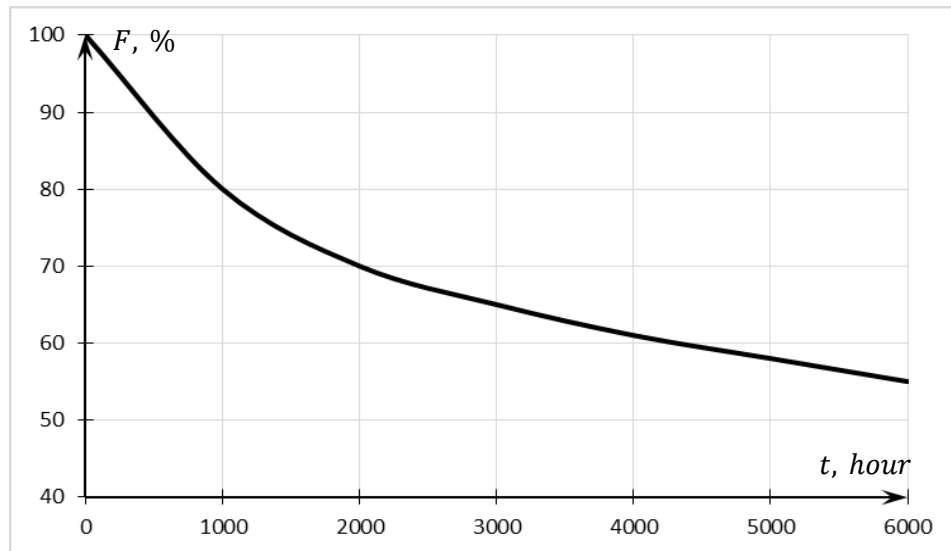

Figure 19 - Changing of lighting flow by fluorescent lamps during their lifetime period [24]

From the graph, I can see that lighting efficiency of fluorescent lamps is falling down significantly. The minimum level of lighting in a lecture room is 270 lx [16]. Thus, according to calculations provided above the efficiency of fluorescent lamps can be decreased on 45%. Then the lifetime period for fluorescent lamps will be 6000 hours (2 years).

Let's consider the lighting system reconstruction. I offer to replace fluorescent lamps by LED lamps. To minimize construction activities the arrangement of the lamps stays the same (**Error! Reference source not found.**). Thus, in the lecture room there are 48 LED sets of lamps with consumed power 30 W.

Required light flow according to formula (2):

$$F = \frac{300 \cdot 144 \cdot 1,5 \cdot 1,1}{48 \cdot 0,45} = 3300 \text{ lm}$$

In frame of reconstruction DS-Office-30 LED lamps are used. Their technical parameters are represented in the Table 8.

Table 8 - Technical parameters of DS-Office-30 LED lamps

Voltage, V	Power, W	Light flow, lm
220	30	3500

The main parameters of lighting installation with LED lamps:

According to formula (3) power of lighting installation is:

$$P_{L.inst.} = 48 \cdot 30 = 1,44 \text{ kW}$$

Electrical energy consumed by lighting installation during a year (formula (4)):

$$W = 1440 \cdot 10 \cdot 247 = 2\,816 \text{ kWh}$$

Checking the condition:

$$0,9 \cdot E_n \leq E_{calc} \leq 1,2 \cdot E_n$$

$$E_{calc} = \frac{3500 \cdot 48 \cdot 0,45}{144 \cdot 1,5 \cdot 1,1} = 318,18 \text{ lx [formula (6)]}$$

$$270 \leq 318,18 \leq 360 \text{ [formula (5)]}$$

Thus, the condition is satisfied. Lighting level is in the frame of required range [16]. If to compare two calculated variants I can conclude that LED lamps usage is more effective. In the case of LED lamps usage lighting level is in frame of required range [16]. LED lamps consume less electrical energy in comparison with fluorescent lamps and this fact allows decreasing of electrical energy consumption by lighting installations.

With assumption of light flow degradation life time period of LED lamps can be identified from the graph below.

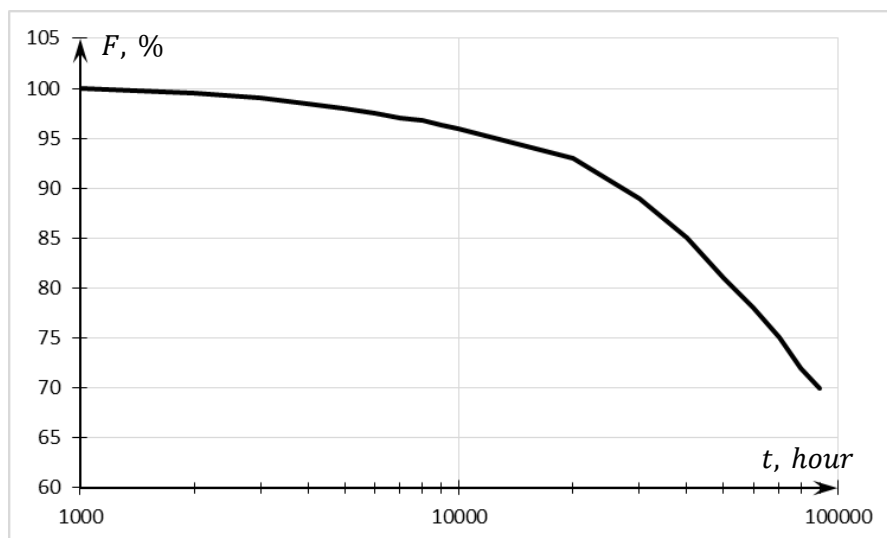

Figure 20 - Changing of lighting flow by LED lamps during their lifetime period [25]

The minimum level of lighting in a lecture room is 270 lx [16]. Thus, according to calculations provided above the efficiency of LED lamps can decrease on 18%. Then the lifetime period for LED lamps 50 000 hours (20 years).

4.4.2 Automatic control of lighting level in classes

Automatic lighting control system allows using natural lighting maximally. Electrical energy consumption reduction can be achieved by decreasing the rate of usage of artificial lighting. Why should we pay more for EE consumption if we can use natural lighting?! It is known that the task to predict the level of natural lighting is very complicated since the weather depends on many factors. However, implementation of automatic lighting control system will provide optimal lighting system operation. The system will turn on the lighting installations when it will be necessary providing additional economic benefit, comfort conditions and electrical energy saving.

For decreasing electrical energy consumption by lighting installations development of effective control system with minimal human participation during its operation is required. The system has to provide maximal energy efficiency within the required lighting level.

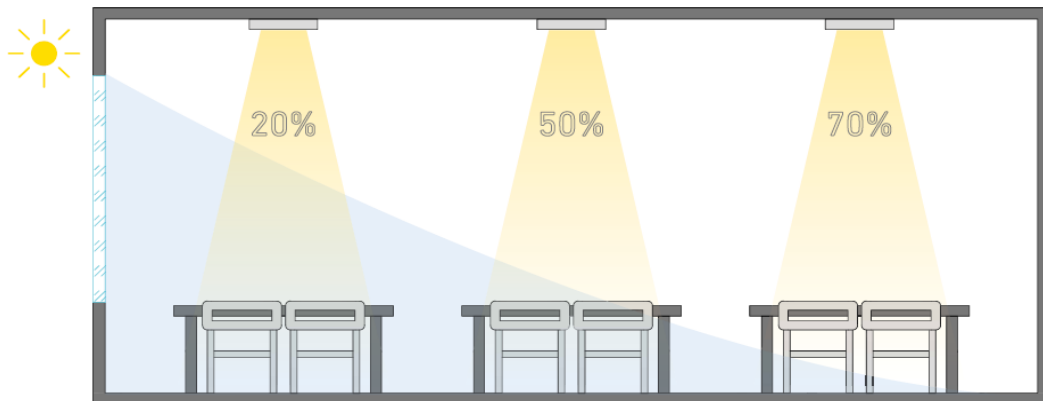

Figure 21 - Daylight extension in a lecture room [26]

Figure 21 shows two possible ways of electrical energy reduction by lighting installations. The first option is complete shutdown of some lighting installations if there is no necessity in their usage since natural lighting is unevenly extended. The second option includes smooth adjustment of the light flow of separated installations within the required lighting level.

Rate of natural lighting in room with lighting aperture area allows significant reducing of electrical energy consumption by lighting installations which depends on climate conditions, day duration in the region and the parameters of lighting aperture area [27]. Figure 21 shows operational principle of smooth adjustment system where daily cycle of natural lighting is taken into account.

The bell-shaped curve represents natural lighting in ideal conditions (cloudiness, clear weather conditions). According to Figure 22 from the moment of time t_2 till the moment t_3 there is no necessity in artificial lighting. During other time periods the lack of natural lighting is observed. It causes usage of additional artificial lighting, however, there is no necessity to use lighting installations in maximum power operation.

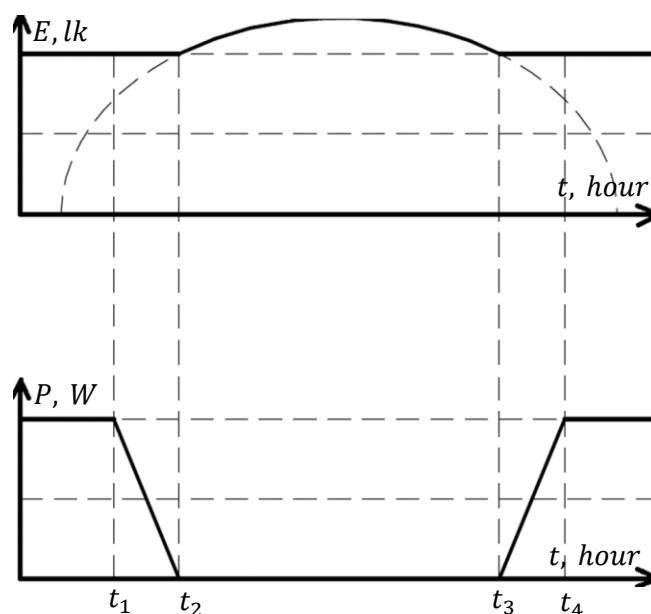

Figure 22 - Operational principle of smooth lighting adjustment

The lighting level in a room depends on a season, time of a day, cloudiness and rate of natural lighting. That rate depends on the size of lighting aperture area, translucency, presents of another buildings and trees around of the object of research.

4.4.3 Technical realization of lighting level control system in lecture rooms

Nowadays there are a lot of different offers in the market in the field of lighting level control. I analyzed offers of many companies (such as Schneider Electric, Philips, Levion, Svetovye technologii and ext.) and decided to use products of DISANO company on my work. The products of this company have acceptable price in comparison with other companies, satisfy to all necessary requirements for product quality, moreover, the company offers a set of equipment depending on concrete type of room [28].

For realization of automatic lighting control system the following equipment produced by DISANO company will be used [28]:

- Multisensor (luminance sensor, presence sensor)
- Case for mounting on the ceiling (det. 589)
- Remote control (det. 596)
- Lamp DALI (1341)

Multisensor monitors human presence and unchanging level of lighting and provides electrical energy saving when there is nobody in the room or when the level of natural lighting is sufficient. Entrance modules allow using connected to the system standard switchgears for turning off/turning on of the lighting or for lighting adjustment.

Till 15 DALI starts can be connected to multisensor. Lamps are turned on only when the sensor notices human presence in the room and they are turned off when there is no movement there. Even if a room full of people lamps can be turned off in the condition that there is sufficient level of natural lighting in the room. There is a possibility of system remote control.

Incoming natural light gives a signal to decrease the power of lamps. The sensor identifies presence of people in the room. These data allow adjustment of lamps power during definite period of time [28].

Below different modes of automatic lighting control system operation are considered.

It is known that during a day there are seven classes in a lecture room and pauses between classes last 20 minutes. The first possible mode of operation is when lighting installations are turned on during the whole working day and they are turned off only during pauses time and during time when there is no people in a lecture room.

Another mode of operation includes taking into account natural lighting. Control system will turn off lighting installations in case of sufficient level of natural lighting in lecture room.

Natural lighting has more qualitative spectral structure than any artificial lighting which is created by any lighting sources. Moreover, if the natural lighting in a room is enough then there is no necessity to use artificial lighting and it allows saving electrical energy consumption. There is a notion of coefficient of natural lighting (CNL) which allows estimating of natural lighting usage rate. Coefficient

of natural lighting is indoor lighting level ratio (E_{in}) to outdoor lighting ratio (E_{out}), expressed in percentage [27]:

$$CNL = \frac{E_{in}}{E_{out}} \cdot 100\%$$

In frame of my research, from 2015, November till 2015, December I conducted periodic measurements of natural lighting level in the lecture room of considered educational building. For measurements, I have chosen two lines of controlling points in sections A and B, every section includes five points (Figure 23). Section A includes points which are located in front of lighting aperture area and section B includes points located between lighting aperture area. The measurements were conducted on the working area – tables.

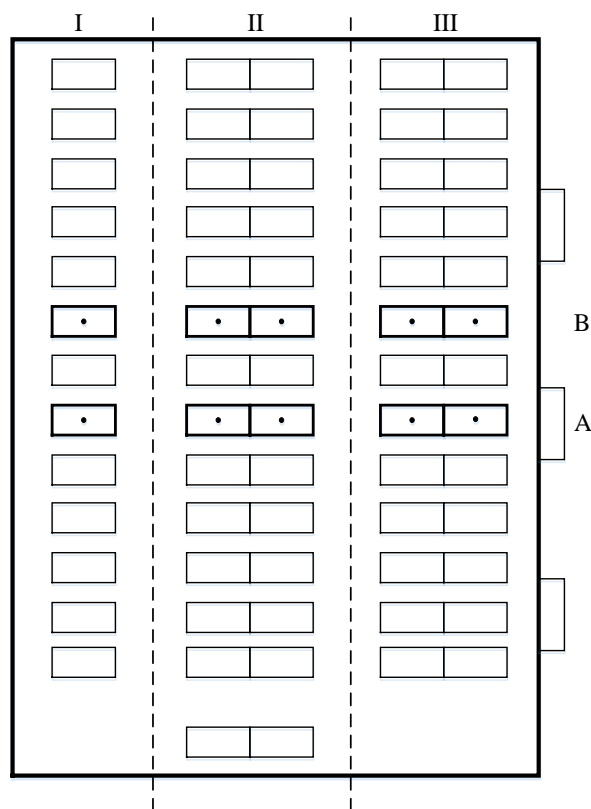

Figure 23 - Scheme of lecture room

The graphs bellow show arrangement of lighting flow in the lecture room. The measurements were conducted on the tables which are located in front of lighting aperture area (Figure 24) and between them (Figure 25).

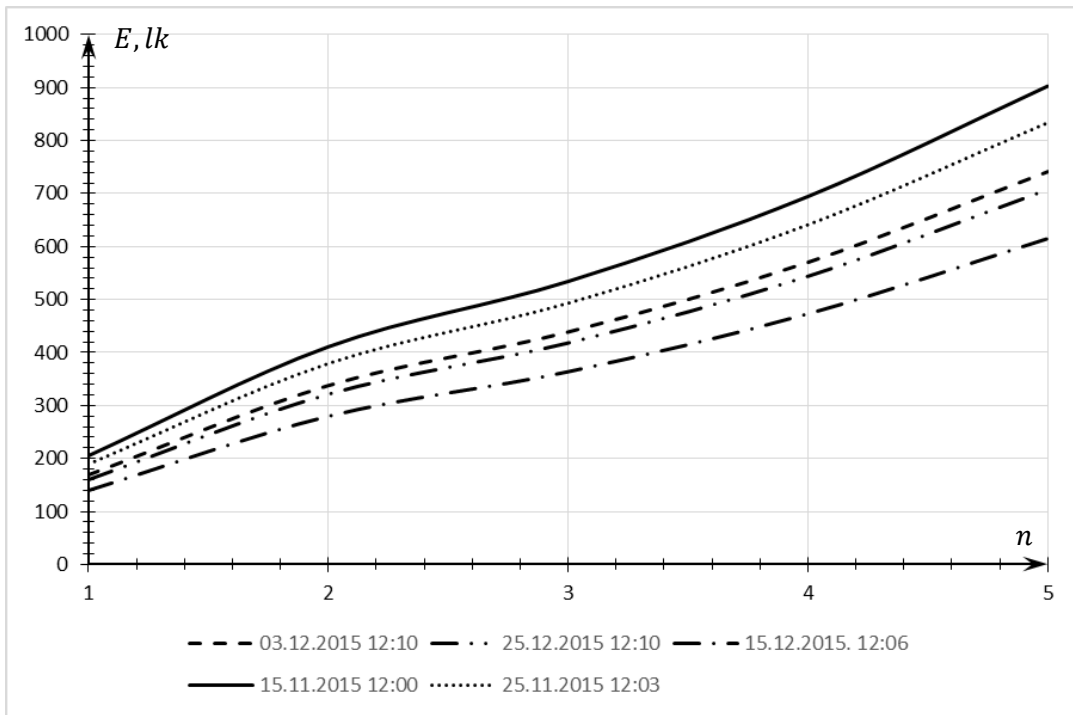

Figure 24 - Curves of changing natural lighting level on the tables located in front of lighting aperture area

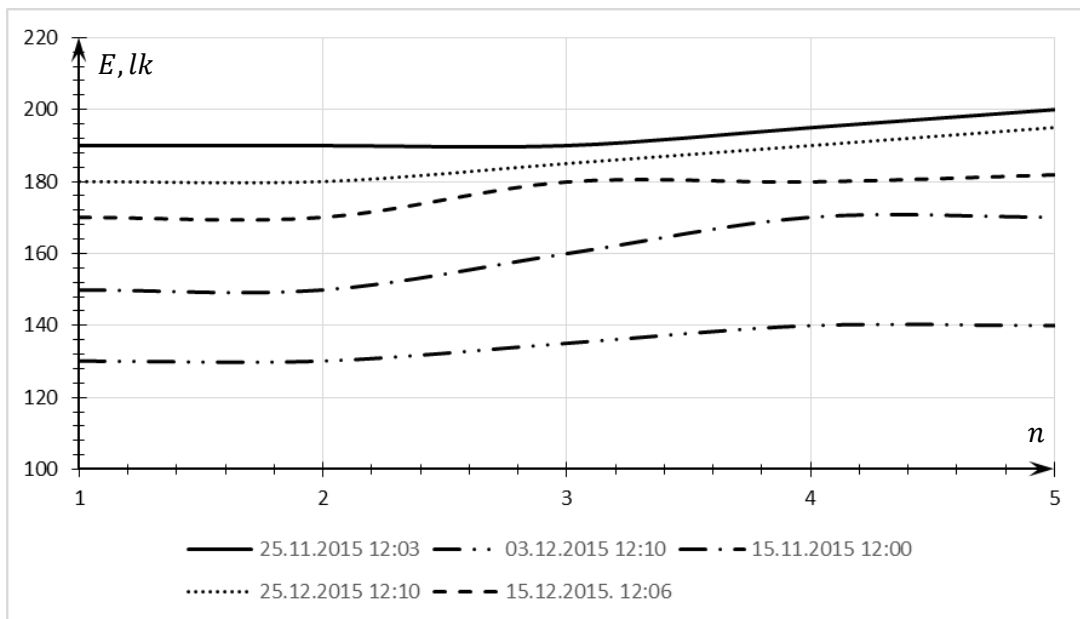

Figure 25 - Curves of changing lighting level on the tables located between lighting aperture area

There is a lack of natural lighting level (less than 400 lx) at the first and at the second point during the considered season. Moreover, there is a significant shortage of natural lighting at every point which is located between lighting aperture area. The graphs show that a line of tables which are located along windows gets sufficient level of lighting (400 lx) when the second and the third lines get not sufficient lighting level. If I separate the control of lighting installations into three groups (I-III lines) (Figure 23) then it will help to reduce payment for electrical energy consumption in that room on about one third part [27].

The lighting control systems offered by DISANO company allow realizing smooth adjustment of lighting level of lamps groups reacting to signals sent by photo sensors. Moreover, the adjustment is

provided discretely according to identified in advance the limited values of natural lighting level and related rate of lighting installation line usage.

Functional dependence CNL on the size of the room, objects arrangement relatively lighting aperture area allows usage of CNL value in the operational algorithm of lighting control system for smooth adjustment of lighting installations and reaching bigger electrical energy savings. Figure 26 represents functional dependence on lighting arrangement in lecture room.

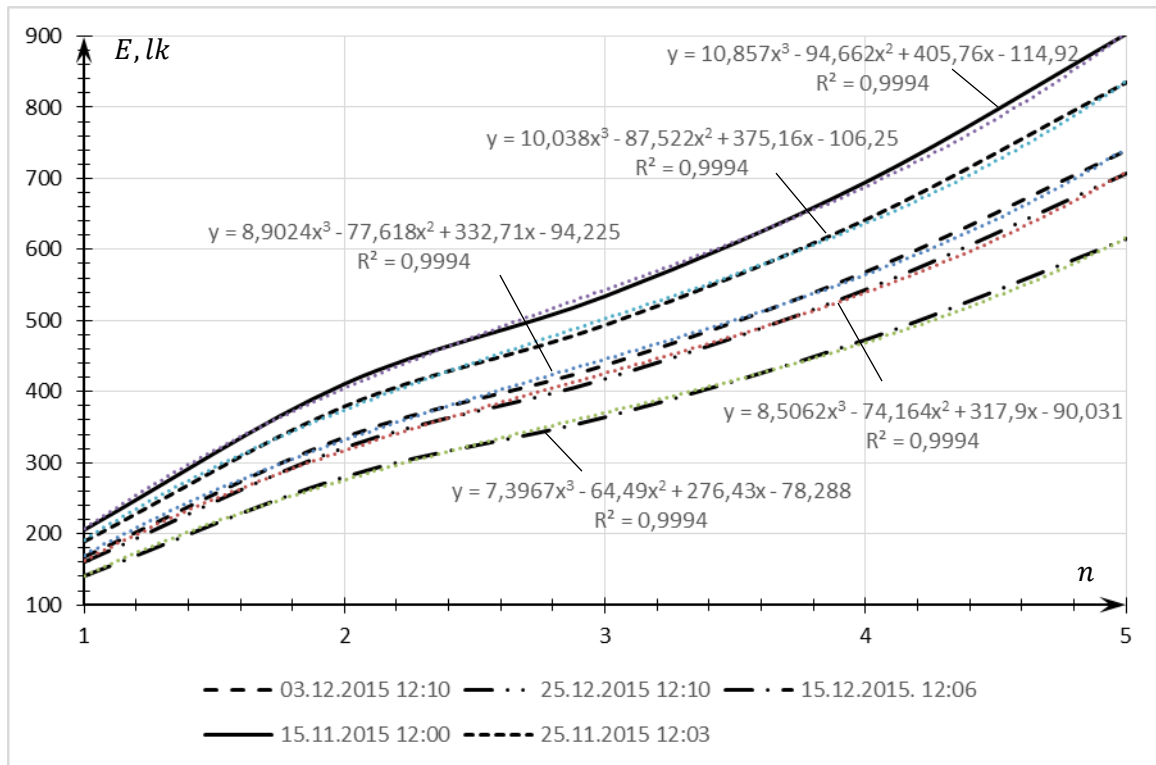

Figure 26 - Trendlines of natural lighting level

According to trend lines on the Figure 26 I can distinguish that the closest function which describes the given dependence is polynomial function of the third degree:

$$E_{nat} = ax^3 + bx^2 + cx + d$$

Coefficients dependence on natural lighting level is represented in the Table 9.

Table 9 – Coefficients dependence on natural lighting level

Natural lighting level E_{nat} , lx	Coefficients			
	a	b	c	d
842,96	10,86	-94,66	405,76	-114,92
779,41	10,04	-87,52	375,16	-106,25
691,09	8,9	-77,62	332,71	-94,26
660,39	8,51	-74,17	317,9	-90,03
574,76	7,4	-64,49	276,43	-78,288

Automatic lighting control system is based on the programmable logic controller. The controller allows to perform digital processing of input signal according to programmed algorithm and to affect on the output signal. Using the controller it is possible to develop complicated programs which include arithmetic, therefore, I can realize developing algorithm on the practice [29].

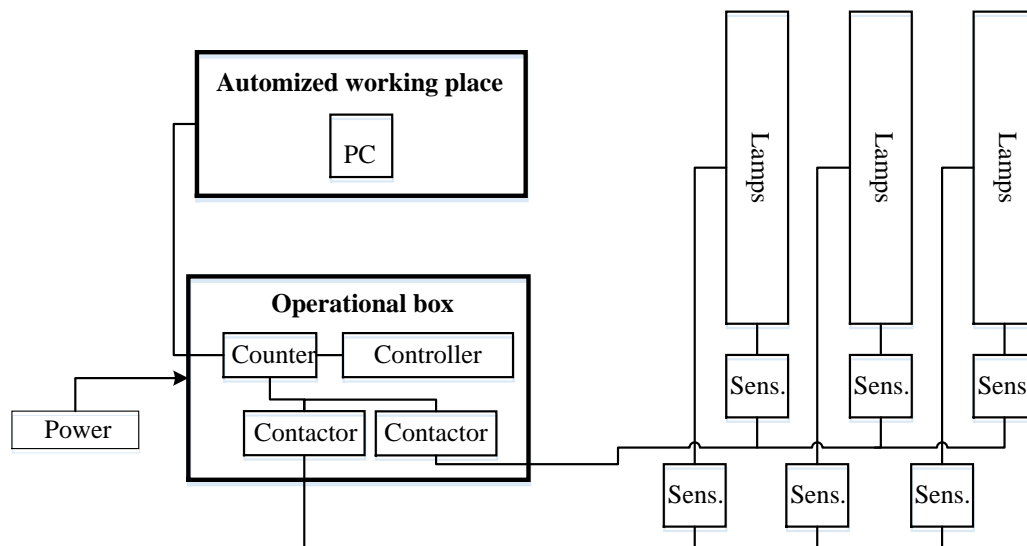

Figure 27 - Scheme of automatic lighting control system

On the Figure 27 designed scheme of automatic lighting control system is represented with taking into account measured in advance CNL for every line of lighting installation in the lecture room. Lighting sensor with analog interface from 1 till 10 V is used as a source of input signal of natural lighting. After entering to a program the value of the signal is converted to absolute value. After it, based on the CNL value, current level of natural lighting is calculated for every line of lighting installations and then it is compared with minimal required lighting level. If condition of minimal lighting level is not satisfied then related line of lighting installations will be turned on by sending the control signal to related controller output [29].

Automatic lighting control system can operate in different modes. Let's consider efficiency of the system in different modes operation.

1. Turns off lights system during different periods of time

It is known that there are seven classes during a day (each class lasts 1,5 hours) in a lecture room and each pause between classes lasts 20 minutes. Thus, the total time of classes during a day is 10,5 hours and the total time of pauses between class is two hours. Let's assume that lighting installations are turned on during the whole working day. Thus, lighting installations will be turned off during two hours from 12,5 working hours.

The power consumed by lighting installations with LED (from chapter 4.4.1):

$$P_{L.inst} = 1,44 \text{ kW}$$

Electrical energy consumed during a day (the time off is taken into account) is:

$$W_E = P_{L.inst} \cdot T \quad (7)$$

$$W_E = 1,44 \cdot 10,5 = 15,12 \text{ kWh}$$

Where:

T – time during which lighting installations are in operation.

Thus, working in this mode during one year the following amount of energy could be saved:

$$W_s = (P_{l.inst} \cdot T_{wd} - W_E) \cdot D \quad (8)$$

$$W_s = (1,44 \cdot 12,5 - 15,12) \cdot 247 = 711 \text{ kWh.}$$

Where:

T_{wd} – time of working day duration in an educational building;

D – quantity of working days per a year.

Let's assume that the lecture room has less than seven classes per a day. If during a day there are six classes then in case of lighting control system implementation lamps will be turned off during 3,5 hours (two hours for pauses, 1,5 hours for a class).

Thus, according to formula 7, electrical energy consumed during a day (the time off is taken into account) is:

$$W_E = 1,44 \cdot 9 = 12,96 \text{ kWh}$$

Working in this mode during one year the following amount of energy could be saved (formula 8):

$$W_s = (1,44 \cdot 12,5 - 12,96) \cdot 247 = 1\,245 \text{ kWh}$$

Table 10 shows calculated data in case of turning off lighting installations during different periods of time.

Table 10 - Consumed electrical energy in case of turning off lighting installation during different periods of time

Pauses duration, hour	Consumed electrical energy with taking into account pauses, kWh	Saved energy from electrical energy consumption during a year, kWh
2	15,12	711
3,5	12,96	1 245
5	10,8	1 778
6,5	8,64	2 312
8	6,48	2 845
9,5	4,32	3 379
11	2,16	3 912
12,5	0	4 446

2. Adjusting of lighting level depending on natural lighting

Let's estimate savings from implementation of lighting control system which adjusts lighting level in the room depending on natural lighting. Thus, If I reduce brightness of lighting installations with taking into account lighting distribution (Figure 21) then consumed electrical energy by lighting installations during a working day will be the following:

$$W_E = P_{l.inst} \cdot (0,2 + 0,5 + 0,7) \cdot T \quad (9)$$

$$W_E = 0,48 \cdot 1,4 \cdot 12,5 = 8,4 \text{ kWh}$$

Where:

0,2; 0,5; and 0,7 – coefficients of brightness for every row relatively.

In this case, according to formula 8, such mode of operation will allow to decreasing of electrical energy consumption on the following value:

$$W_s = (1,44 \cdot 12,5 - 8,4) \cdot 247 = 2\,371 \text{ kWh}$$

If during pauses between classes the lighting installations will be turned off then consumed electrical energy will be (formula 13):

$$W_E = 0,48 \cdot (0,2 + 0,5 + 0,7) \cdot 10,5 = 7,06 \text{ kWh}$$

In this case, such mode allows to save (formula 8):

$$W_s = (1,44 \cdot 12,5 - 7,06) \cdot 247 = 2\,703 \text{ kWh}$$

Table 11 shows calculated data in case of turning off lighting installations during different periods of time with different electrical energy consumption by lighting installations lines.

Table 11 - Consumed electrical energy in case of turning off lighting installation during different periods of time

Pauses duration, hour	Consumed electrical energy with taking into account pauses, kWh	Saved energy from electrical energy consumption during a year, kWh
0	8,4	2 371
2	7,06	2 703
3,5	4,32	2 952
5	3,6	3 201
6,5	2,88	3 450
8	2,16	3 699
9,5	1,44	3 948
11	0,72	4 197
12,5	0	4 446

As I can see from the Table 11 lighting level adjusting with taking into account distribution of natural lighting allows to observe bigger savings of electrical energy.

5. Economic evaluation of proposed energy saving measures

A comparison from economical point of view of offered above measures which will allow saving of electrical energy consumption is represented in this chapter. The main point is not only to know how much energy would be possible to save by implementation of definite measure but as well to know the initial investments which is required for a definite measure. Moreover, I should take into account possible changes of main inputs.

5.1 Methodology of economic evaluation

There is a necessity in creation of criteria according to which both offered measures, which require investments and which do not require investments, will be compared. The main economical criterion according to which I can compare the implementation of energy efficiency measured are following:

- Net Present Value (NPV)
- Internal Rate of Return (IRR)
- Discounted Payback Period (DPBP)

The first criterion is *Net Present Value (NPV)*:

$$NPV = \sum_{t=1}^T \frac{C_t}{(1+r)^t} - C_0 \quad (10)$$

Where:

C_t – net cash inflow during the period t ;

C_0 – total initial investment costs;

r – discount rate;

t – number of time periods.

NPV shows the difference between present value of cash inflows and present value of cash outflows. However, in current project there are no cash inflows, thus NPV for each possible measure will be calculated based on payment for electrical energy with taking into account every year tariff growth, inflation rate and lifetime period of the project. As in basis of NPV calculation lies only expenses then NPV for all considered measures will be negative and higher rate of NPV will represents more desirable variant.

The next criterion includes *Internal Rate of Return (IRR)*:

$$NPV = \sum_{t=1}^T \frac{C_t}{(1+IRR)^t} - C_0 = 0 \quad (11)$$

IRR value shows discount rate that makes NPV equals zero. IRR depends on initial investments and cash flow during the time. The project with higher IRR is considered like more successful.

Finally, the last criteria of efficiency comparison of offered measures is *Discounted Payback Period (DPBP)*:

$$NPV = \sum_{t=1}^{DPBP} \frac{C_t}{(1+r)^t} - C_0 = 0 \quad (7)$$

DPBP represents number of years necessary to recover the project investments. For calculation of such criteria savings from electrical energy payment for every year were considered.

I would like to notice that in my work the NVP is the main criterion in economical comparison of offered measures because this value can be adjusted according to considered period, it takes into account value of money and all considered costs, thus, the NPV comparison is the most evident and clear way.

5.2 Economic evaluation of measures which do not require any initial investments

Measures which do not require any investments include local heaters usage elimination. Local heaters consume additional 32 270 kWh of electrical energy during heating period, consequently, in the bill for electrical energy consumption there is additional 104 900 rub/year.

As it was mentioned in the chapter 4.3 elimination of local heaters is not sufficient. For supporting inside temperature increasing of heating rate was offered. If local heaters usage will be eliminated and instead of it consumption of thermal energy will be increased on 32 268 kWh (28 Gcal) then additional payment for heating will be 33 700 rub/year. Implementation of such measure will allow to save 71 200 rub/year.

Additional measure which controls restriction of local heaters usage is usage of circuit breakers for every room where people work during significant time. Circuit breakers implementation demands investments 5 000 rub. I should notice that lifetime period of circuit breaker is 10 years. Thus, such measure will allow to save sufficient amount of energy and reduce payment for electrical energy consumption.

In frame of economic evaluation, I estimate payment for electrical energy consumption and payment for heating. The first (existing) variant includes payment for EE and payment for heating before local heaters replacement, the second variant includes payment for EE and payment for heating after local heaters replacement and after increasing of thermal energy consumption. Initial data for economic evaluation of offered changes are represented in tTable 12.

Table 12 - Initial data for local heaters elimination project evaluation

Variant	1	2
Consumed electrical energy per a year, kWh	578 920	546 620
Consumed thermal energy per a year, Gcal	2 650	2 678
Considered time, years	20	20

The following information were used during calculation:

- Real discount rate = 3 %
- Inflation rate = 5% [30]
- Tariff increasing rate for electrical energy = 12% [31]

- Tariff increasing rate for thermal energy = 5% [31]

The result of calculation is presented in Table 13

Table 13 - Calculated data for economical evaluation of local heaters replacement

Variant	1	2
NPV, rub	-95 025 518	-86 533 660
Payment per a year, rub:		
Electrical energy	5 098 304	4 174 348
Thermal energy	4 688 542	4 737 688

Thus, as we can see from the Table 13 elimination of local heaters usage will allow decreasing of total payment for electrical energy and thermal energy. Even that after increasing consumption of thermal energy payment for thermal energy slightly increase, however, it compensates by significant reduction of payment for electrical energy.

5.2.1 Sensitivity analysis for heaters elimination measure

Let's consider resistance of considered measure to input changes.

1. Changing of inflation rate

According to historical data [30] current inflation rate in Russian Federation is 5%. Let's consider the situation of inflation rate changing.

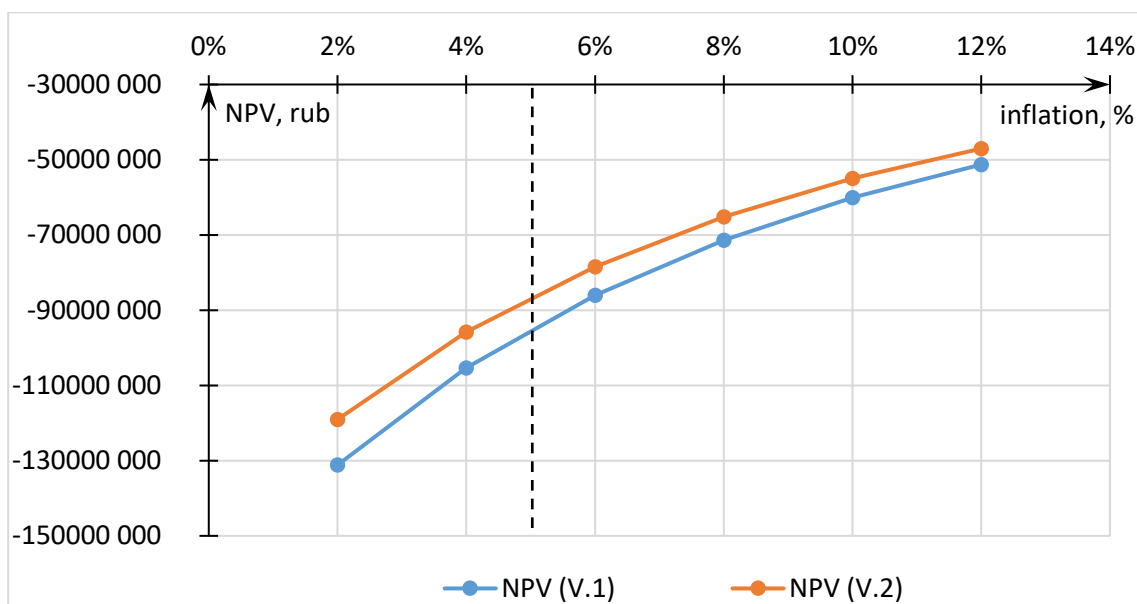

Figure 28 - Dependence NPV on inflation rate

The graph above shows that with inflation growth NPV will increase, however, only when inflation rate will be very high NPV of existing variant will cross NPV of variant with local heaters replacement. However, such occasion has very small probability. Thus, according to Figure 28 in frame of the most probable range of inflation rate changing variant with local heaters replacements is preferable.

2. Changing of real discount rate

The figure below shows how changing of real discount rate influence on NPV.

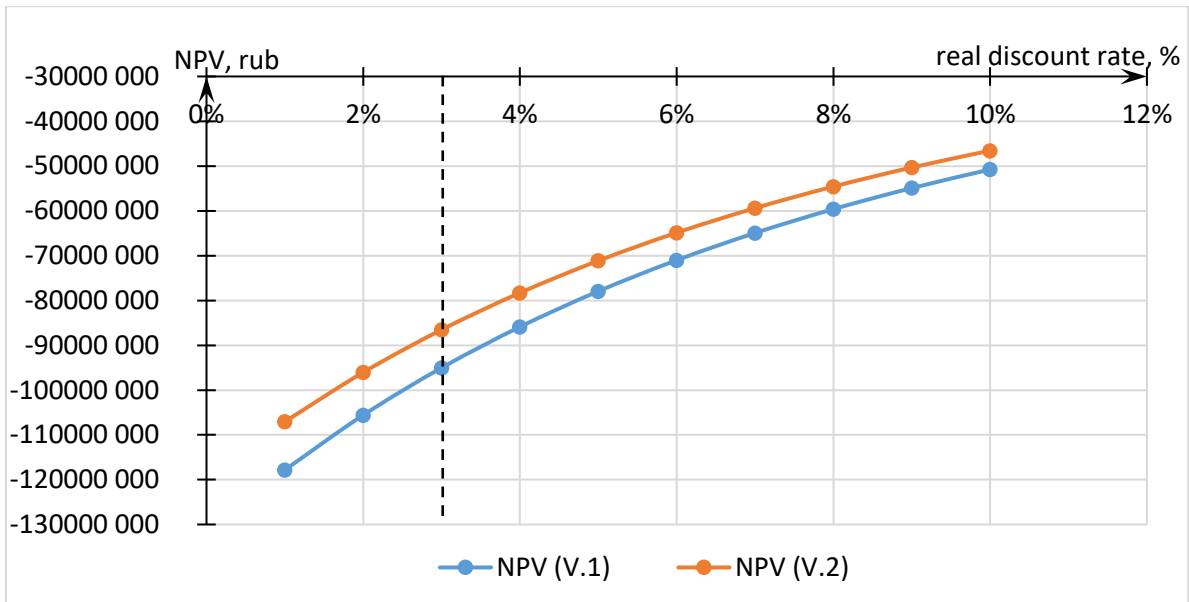

Figure 29 - NPV dependence on real discount rate

With the discount rate growth NPV for each variant is growing as well. The value of discount rate is introduced by user. Usually for such projects discount rate is in frame of 2-4%, therefore, changing of discount rate does not influence on decision making about local heaters elimination.

3. Changing of electrical energy consumption and heating rates

Let's consider the situation when rate of electrical energy consumption will be changed. It can be caused by changing of educational process, by influence on people behaviour concerning electrical energy consumption. Heat consumption rate in the building can be changed due to deliberate actions which can be connected with climate reasons.

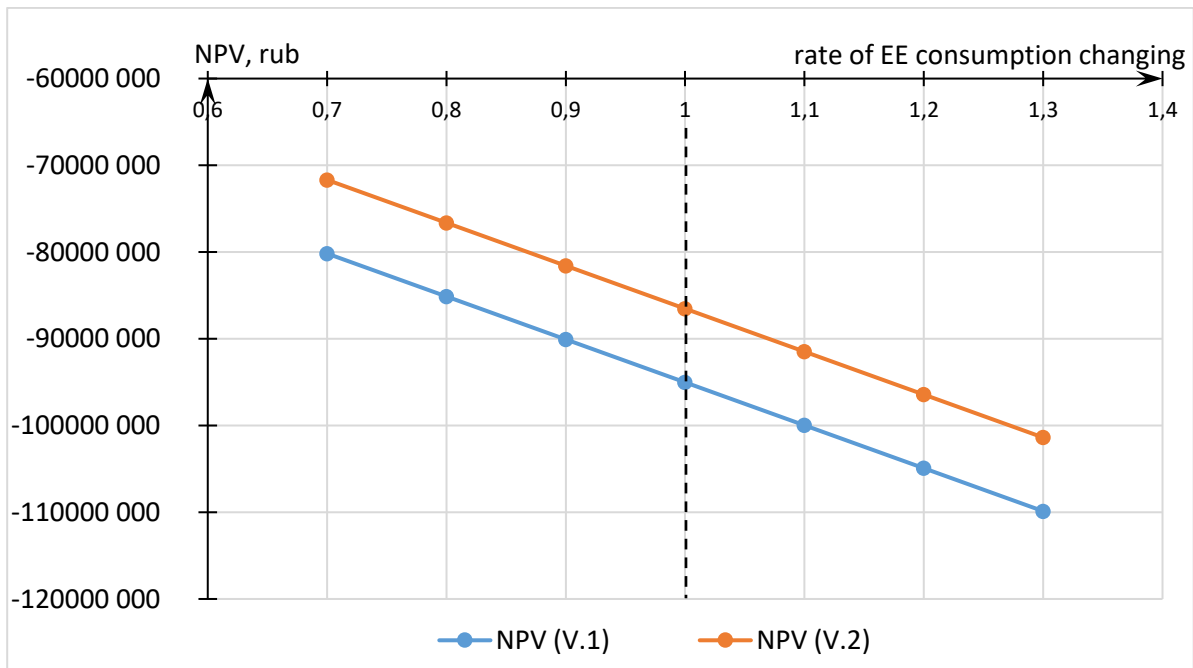

Figure 30 - NPV dependence on electrical energy consumption rate

On Figure 31 is represented NPV dependence on heating rate changing.

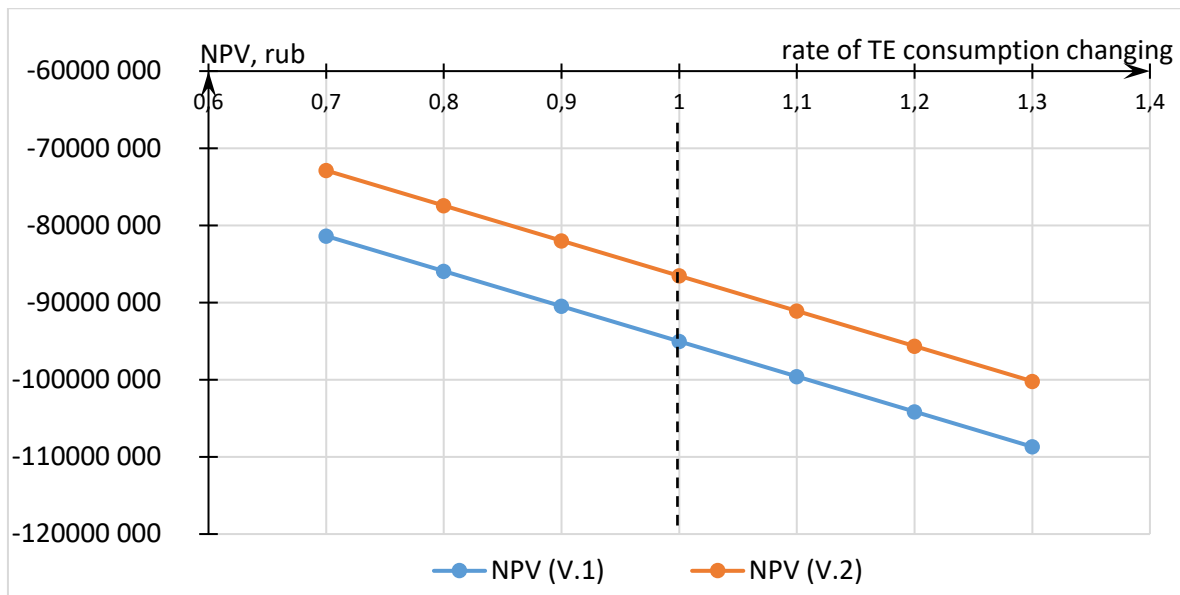

Figure 31 - NPV dependence on heating rate changing

According to Figure 30 and Figure 31 changing of electrical energy consumption rate and heating rate have the same influence on NPV. With increasing any of these values, dynamic of NPV changing is the same. With the growth of consumption NPV increases as well.

Thus, it was revealed during sensitivity analysis that local heaters elimination allows decreasing of payment for electrical energy consumption and not significant increasing payment for heating.

5.3 Economic evaluation of building insulation

As it is shown in the chapter 4.3 building insulation allows significant decreasing of heating losses rate. However, each offered measure demands significant investments. Let's estimate efficiency of building insulation measures implementation.

Necessary data for economic evaluation of building insulation are represented in Table 14.

Table 14 - Initial data for building insulation project evaluation

Variant	Existing	1	2	3	4
Measure		insulation of walls	insulation of ceiling	windows changing	all measures
Demanded heating per a year, Gcal	2 678	2 356	1 938	2 362	1 266
Required investments, rub		22 142 160	14 899 500	10 569 000	47 610 660
Lifetime period, years	20	20	20	20	20

During calculation the following information were used:

- Real discount rate = 3 %
- Inflation rate = 5% [30]
- Tariff increasing rate = 5% [31]

Calculated NPV for each variant is represented in Table 15.

Table 15 - Calculated data for economical evaluation of building insulation

Variant	Existing	1	2	3	4
Measure		insulation of walls	insulation of ceiling	windows changing	all measures
NPV, rub	-46 000 173	-62 621 971	-48 191 968	-51 152 187	-69 361 304
Payment for heating per a year, rub.	4 737 639	6 449 547	4 963 376	5 268 254	7 143 643
IRR		-4%	6%	2%	1%

Thus, after economical evaluation I can notice that none from offered measures will be effective since each measure demands significant investments and saving which could be achieved on payment for heating does not cover all initial expenses during considered period. Moreover, discounted payback period for each measure is more than period of lifetime. I would like to make a conclusion that none of considered ways of building insulation will be effective in frame of considered task.

5.3.1 Sensitivity analysis of building insulation measure

As it was revealed in previous chapter building insulation measures demand significant investment and due to this reason such measure is considered like inefficient from economical point of view. However, let's consider input parameters which can influence on economical effectiveness of this project.

1. Changing of inflation rate

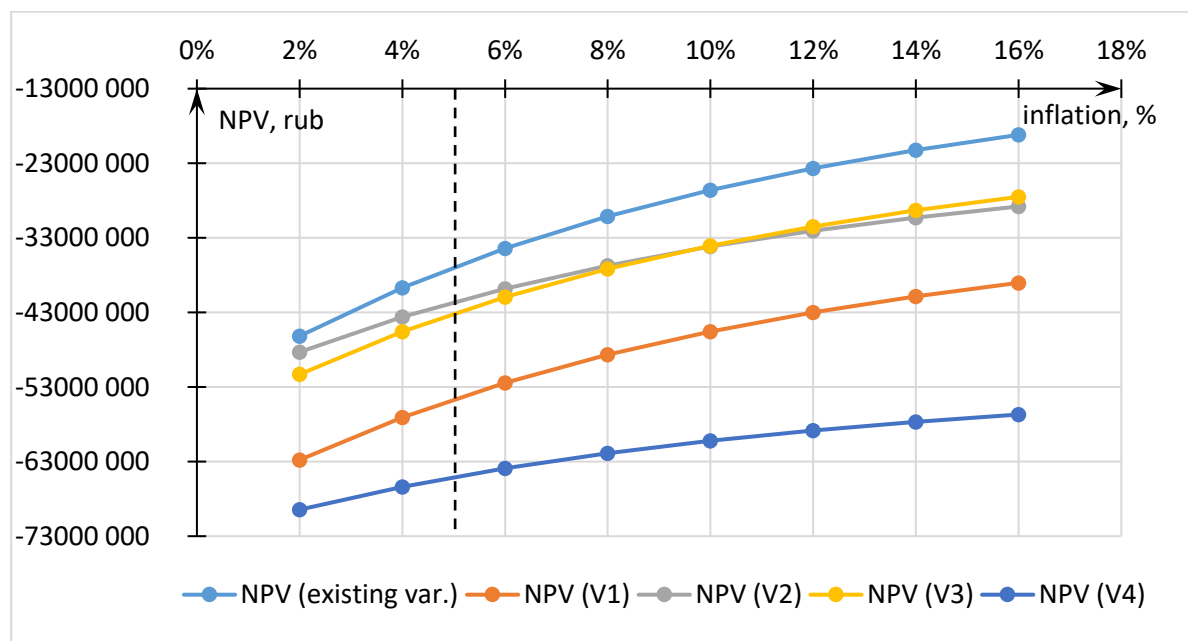

Figure 32 - Dependence NPV on inflation rate

According to Figure 32 with increasing of inflation rate the NPV increases as well. Moreover, difference between NPV for each variant is growing as well with inflation rate increasing. Thus, changing of inflation rate will not influence on made decision.

2. Changing of real discount rate

Let's consider how changing of discount rate will influence on NPV for each variant.

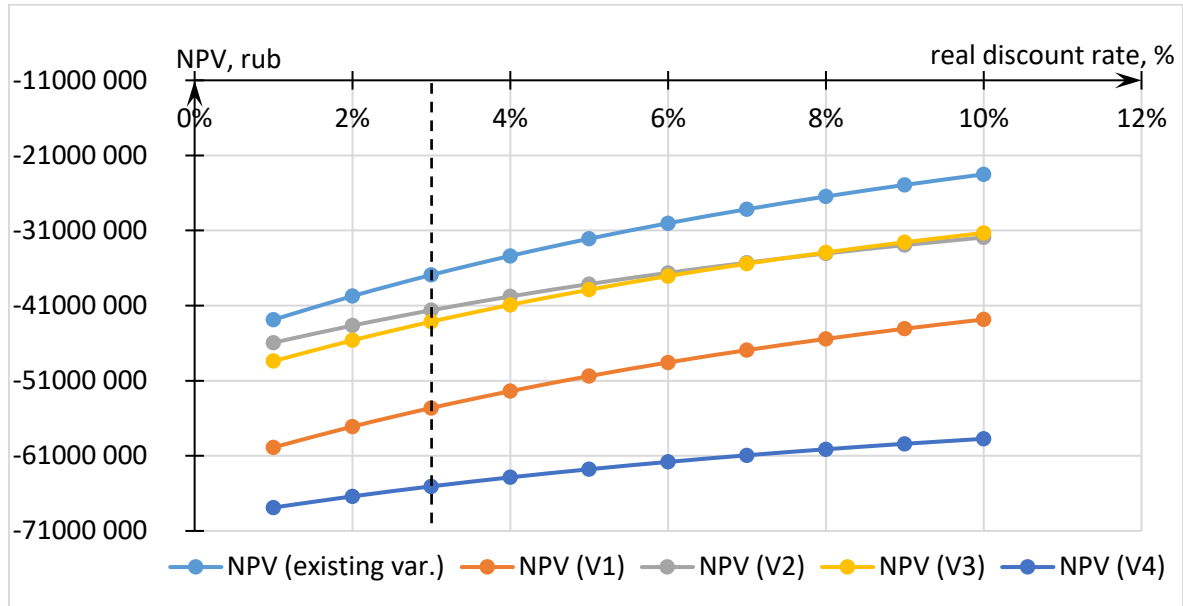

Figure 33 - NPV dependence on real discount rate

With discount rate growth NPV increases. However, within considered case changing of discount rate do not influence on made decision. For all variants NPV increases proportionally. As it was mentioned before, discount rate is identified by user (usually for such projects 2-3%) and at this range there is no significant difference of NPV within offered variants.

3. Changing of investments

Required investments for building insulation differ depending on cost of materials and price list of companies which provide construction work. In my work, I used average rate of investments, however, this value can be changed. Let's analyse how changing of investment rate influence on project NPV.

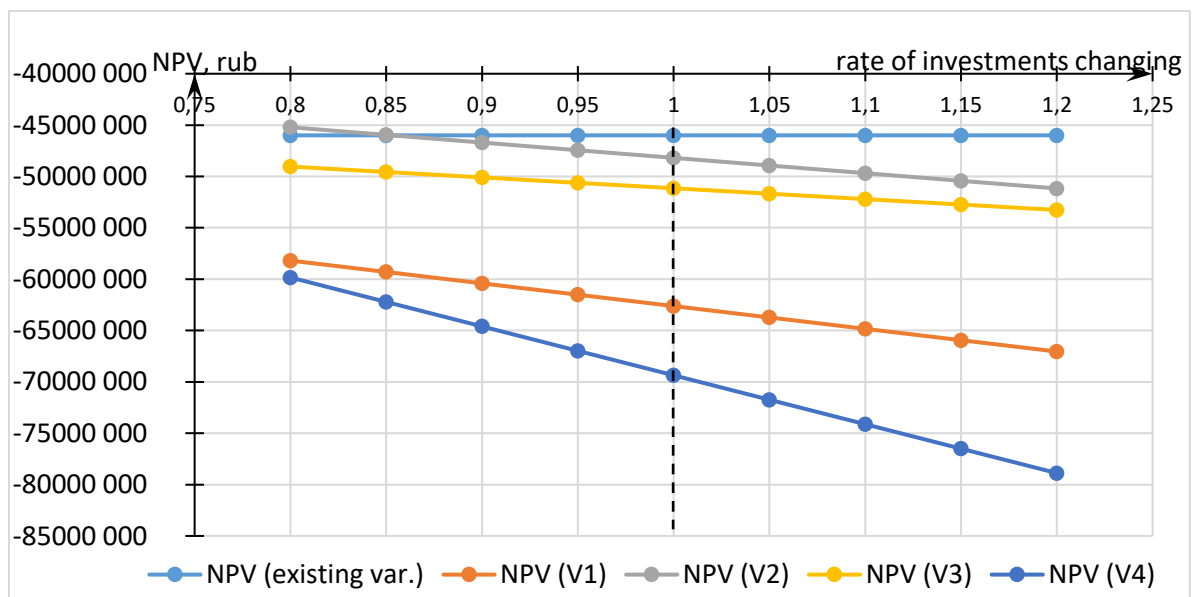

Figure 34 - NPV dependence on investment changing rate

NPV of existing variant stays on the same level because this variant does not demand any investments. If investments are reduced on 20% then there is a reason of ceiling insulation implementation. However, in any other case existing variant stays preferable. In case when it is possible to have financial support from government side in form of subsidies there is a meaning of insulation building measures implementation. If I would like to observe positive effect from insulation measures implementation than minimal value of subsidies should be 30%.

5.4 Economic evaluation of lighting system reconstruction project

I would like to compare three possible variants. The first variant represents the existing situation where like a source of lighting are used fluorescent lamps. The second variant offers changing of fluorescent lamps to LED. Finally, the third variant includes changing fluorescent lamps to LED and implementation of automatic lighting control system. For all variants, the main measure of comparison is NPV.

Firstly, it is necessary to prepare data for economic criteria calculation. For every variant, I need data about installed power of lighting installation, electrical energy consumed by lighting installation, required investments and lifetime period. Calculation of all necessary technical data is represented in chapter 4.4.1. Table 16 shows all data which is necessary for calculation of economic evaluation.

Table 16 - Initial data for lighting reconstruction project evaluation

Variant	1	2	3
Source of lighting	FL	LED	LED
Installed power of lighting installation, kW	3,36	1,14	1,14
Consumed energy per a year, kWh	9 817	2 957	1 660
Required investments, rub			
Tubes	24 960 [32]		
Set	69 264 [32]	137 904 [32]	137 904 [32]
Necessary equipment			52 000 [28]
Lifetime period, Hours	6 000 [24]	50 000 [25]	50 000 [28]
years	2	20	20

During calculation the following information were used:

- Real discount rate = 3 %
- Inflation rate = 5% [30]
- Tariff increasing rate = 12% [31]

The result of calculation is presented in the Table 17

Table 17 - Calculated data for economical evaluation

Variant	1	2	3
NPV, rub	-978 978	-367 763	-318 948
Payment for EE consumption by one lecture room per a year, rub	100 827	37 877	32 849
IRR	-	26%	24%
Payback period, years	-	6	7

According to the Table 17 the best variant is changing fluorescent lamps to LED lamps and implementation of lighting control system. This variant has the highest NPV, however, even changing fluorescent lamps to LED lamps will bring better result than existing lighting system.

5.4.1 Sensitivity analysis for lighting system reconstruction

The external environment is dynamically changing due to this fact in the created economic model I should take into account changing of main input data. Sensitivity analysis is provided below to observe the project dependence on external parameters.

1. Changing of inflation rate

According to historical data [30] current inflation rate in Russian Federation is 5%. Let's consider the situation of inflation rate changing.

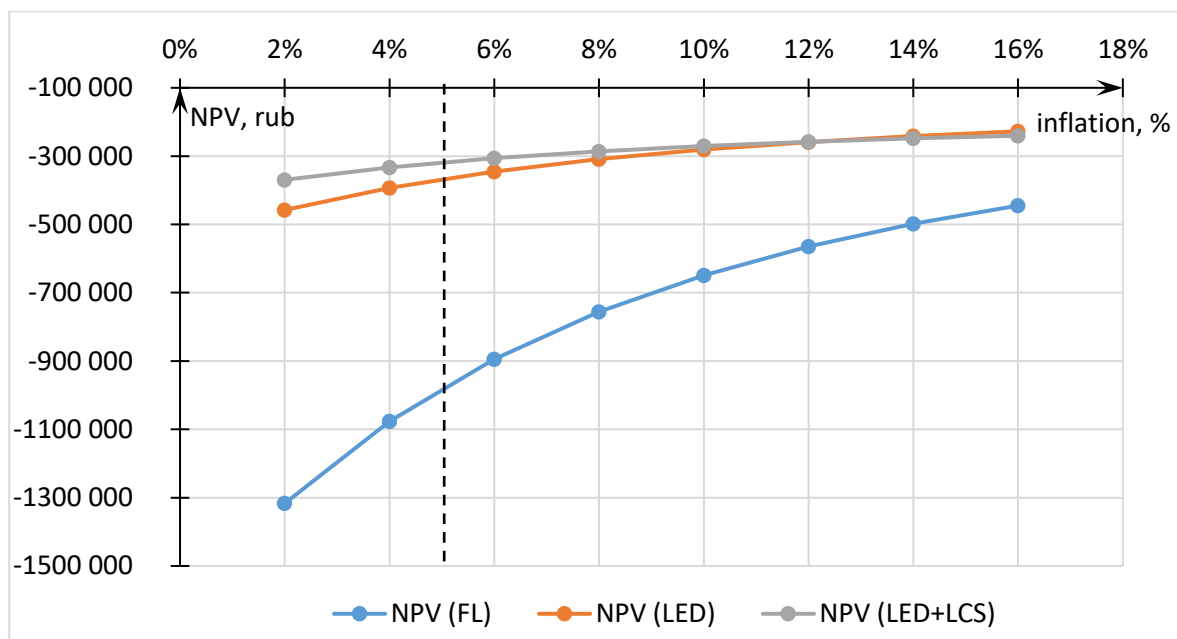

Figure 35 - Dependence NPV on inflation rate

According to the Figure 35 in case of small inflation rate the best variant is still variant with lighting control system, however, when inflation rate will be more than 13% the preferable variant will be only changing of lighting sources to LED lamps. It is worth to notice that with the growing of inflation rate the speed of NPV growth for existing variant is faster than speed of NPV increasing of other variants. However, in case when the rate of inflation will be more than 30% NPV of existing variant will be higher. But such occasion has very small probability and I do not consider it in my work. Thus, in case if inflation rate is less than 13%, what is more probable, I would recommend lighting system reconstruction with lighting control system implementation.

2. Changing of real discount rate

On the figure below represented NPV rate dependence on real discount rate.

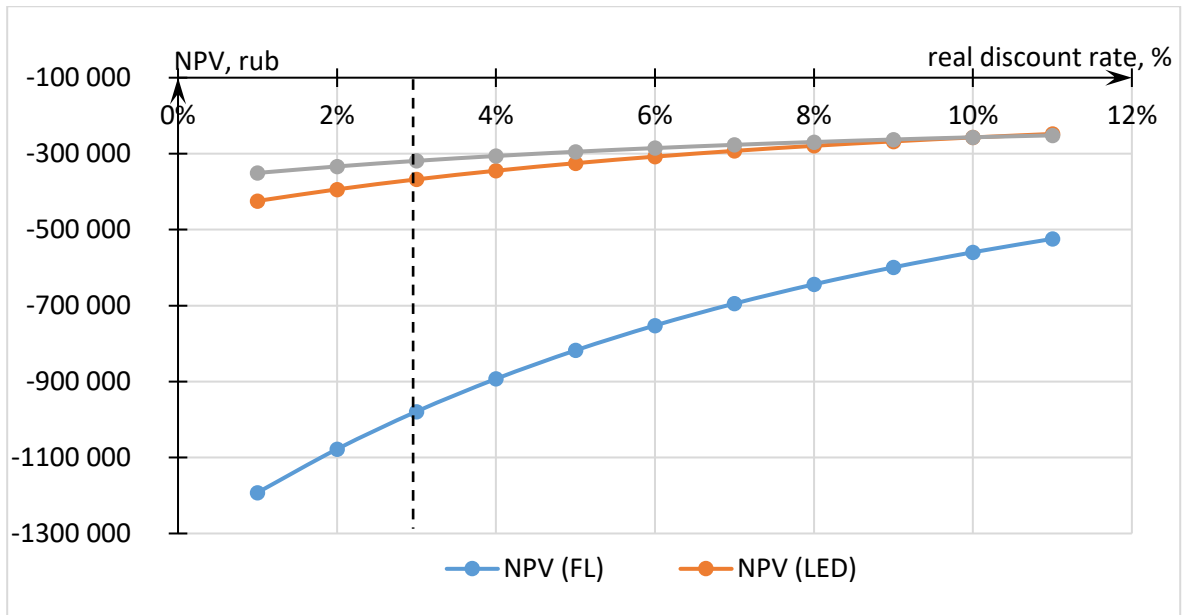

Figure 36 - NPV dependence on real discount rate

With the discount rate growth NPV value is growing as well. However, in case of small real discount rate the NPV of existing variant and the NPV of variant with LED lamp differs in 3 times. Therefore, I can say that reconstruction of lighting system is preferable, however, if the value of real discount rate will be more than 10% in this case I will not recommend implementation of lighting control system. In fact, discount rate is established by the user and for such projects the discount rate is accepted within 2-3%. Thus, depending on real discount rate I recommend providing of lighting system reconstruction with implementation of lighting control system.

3. Changing of electrical energy consumption rate

Let's consider the situation when the rate of EE consumption by lighting installations will be changed due to reason of educational process changing. During my calculation, I assumed that during a day there is time when in a room there is no lectures. However, depending on number of students the quantity of provided classes during a day can be changed. Thus, electrical energy consumption rate by lighting installations will be changed as well.

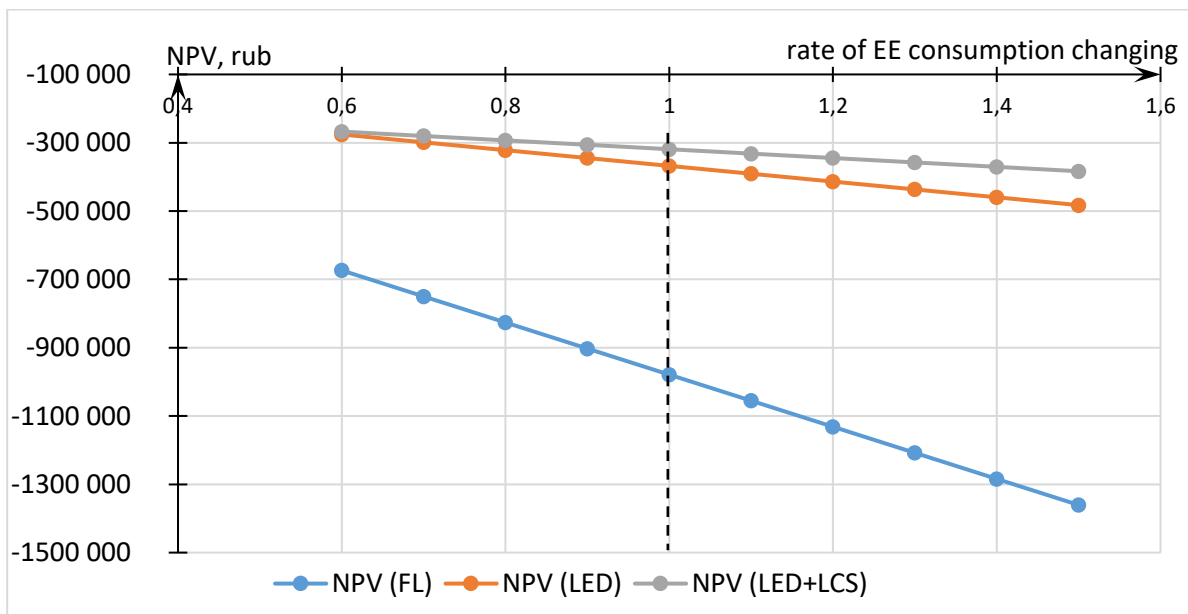

Figure 37 - NPV dependence on electrical energy consumption rate

In case when the lecture room has a lot of pauses between classes NPV rate for lighting system reconstruction and lighting control system implementation is almost on the same level. But when in the lecture room there are a lot of classes during a day NVP of all variants is falling down, however, existing variant has bigger acceleration. Thus, lighting control system implementation will be preferable.

Let's consider the situation when such measures will be implemented more than in one lecture room.

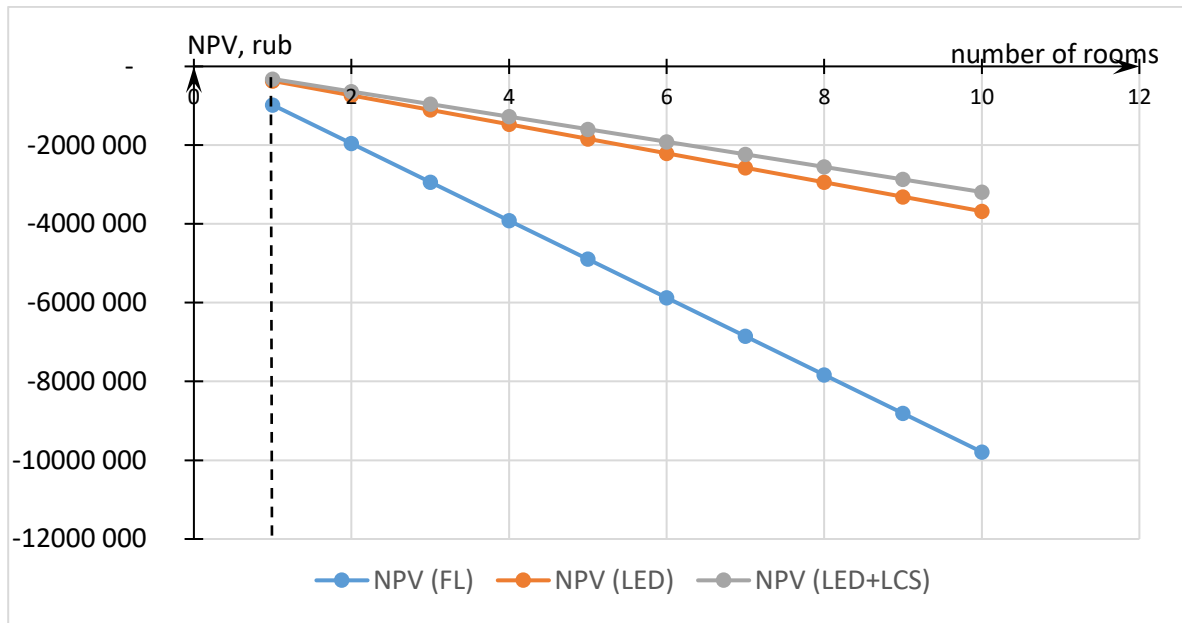

Figure 38 - NPV dependence on different number of room measures implementation

At any case the best variant is reconstruction of lighting system with implementation of lighting control system. Figure 38 shows that with the growth number of lecture rooms where lighting reconstruction is provided NPV for existing variant is falling down faster when for other variants.

Thus, analyzing the influence of the most important inputs I would recommend lighting system reconstruction which includes changing of fluorescent lamps to LED and implementation of lighting control system.

5.5 Analysis of considered variants

As it is possible to notice each measure has its own influence on efficiency of electrical energy usage. Let's analyze how implementation of offered measures influences on energy consumption. Table 18 summarizes effect of each considered earlier measures.

Table 18 - Efficiency of saving measures implementation

Variant	Investments, rub	NPV, rub.	Payment for heating per a year, rub.	Payment for EE consumption per a year, rub.
Existing situation	249 600 ¹	-95 025 518	4 688 550	5 098 300
Local heaters elimination (increased rate of heating)	249 600¹	-86 533 660	4 737 690	4 174 350
<i>Building insulation</i>				
Insulation of walls	22 142 160	-112 124 024	6 449 550	5 098 300
Insulation of ceiling	14 899 500	-97 694 021	4 963 380	5 098 300
Windows changing	10 569 000	-100 654 240	5 268 260	5 098 300
All measures which include building insulation	47 610 660	-118 863 357	7 143 650	5 098 300
<i>Lighting system reconstruction</i>				
LED lighting system	137 900	-75 183 714	4 688 550	3 054 760
Lighting control system	189 900	-72 354 733	4 688 550	2 763 400
Combination of offered measures				
Local heaters elimination + LED+LCS implementation	189 900	-68 700 185	4 737 690	2 337 870

The table above shows that one of the preferable measures is local heaters elimination with increasing the rate of heating. This measure is based on electrical energy consumption and does not require any initial investments. Although, payment for heating grows, however, payment for electrical energy consumption falls down significantly. Thus, local heaters elimination allows to save 874 810 rub/year. Calculation of building insulation measures shows that such measures demand significant investments and due to this fact in frame of my work I do not consider these measures as preferable. What concerns lighting system reconstruction, implementation of lighting control system and replacement of fluorescent lamps allows saving of significant amount of money for electrical energy consumption payment. However, if to connect local heaters replacement measure and implementation of lighting control system then it is possible to observe even better result. This measure allows to save 289 387 kWh of energy per a year or 2 760 439 rub per a year in the payment bill. Based on conducted electrical energy consumption analysis and calculation of possible energy efficiency measures I recommend elimination of local heaters usage with insignificant growth of heating rate and implementation of lighting control system.

¹ Existing variant and elimination of local heaters do not require any initial investment, however, I conducted economical evaluation for period 20 years. During this time there is a necessity to change existing fluorescent lamps due to their lifetime period.

CONCLUSION

In this work, according to Federal law from 23.11.2009 N 261-FZ "About energy savings and increase of electrical efficiency and about amendments in certain legislative acts of Russian Federation" [1], I considered all possible energy efficiency measures in frame of educational building. There is a big range of different energy efficiency measures, however, in current situation measures which I have chosen are limited by financial sources.

Due to fact of financial limitation firstly I offer to implement measures which do not require any initial investment. I conducted a detailed analysis of electrical energy consumption by educational building, during this analysis I detected that due to lack of heating there is irrational usage of local heaters in the educational building. I offer to eliminate usage of local heaters and for saving comfortable conditions for work I offer to increase rate of heating. Thus, such measure does not demand any initial investments, however, it allows saving of 32,3 MWh per a year. Therefore, payment for electrical energy consumption will be significantly decreased and payment for heating will be slightly increased, that in total allows saving of 874 810 rub/year in a payment bill.

Based on the structure of electrical energy consumption in educational building significant part of it is taken by lighting installations. Therefore, I offer reconstruction of existing lighting system. There is a possibility to change fluorescent lamps to LED which is more efficient. Changing of lighting sources does not demand significant investments, however, LED lamps have more advantages in comparison with fluorescent lamps. With taking into account degradation of lighting flow, lifetime period of LED is 10 times more that lifetime period of fluorescent lamps. However, during my calculation I identified that replacing of existing lighting sources will be more efficient as well as implementation of lighting control system. This system allows significant saving of electrical energy. Lighting control system monitors lighting level and adjusts it according to minimal lighting requirement in educational building. This system is efficient due to the fact that it takes into account natural lighting and in case when natural lighting is not sufficient it adjusts lighting level in lecture room to minimally required level. In comparison with existing lighting system lighting control system decreases electrical energy consumption by lighting installation by six times.

To achieve the maximum of electrical energy saving I offer to combine elimination of local heaters and implementation of lighting control system. Combination of these measures is the most preferable measure within existing financial situation. Thus, elimination of local heaters with increased rate of heating in education building and implementation of lighting control system allows saving of 289 390 kWh of energy per a year or 2 760 400 rub per a year in the payment bill.

In case when it is possible to have financial support from government side in form of subsidies for energy saving measures implementation or usage of special funds for financing of such purposes then I would offer implementation of measures which demands more significant investments. For example, if financial support is minimally 30 % from demanded investments then there is a reason of building insulation in form of insulation of ceiling. Ceiling insulation allows decreasing of heat losses on 27% due to this fact it would be possible to decrease payment for heating.

On the example of one educational building I proved that even in situation of limited financing is possible to decrease total payment for electrical energy consumption and payment for heating on 30%. If energy saving measures would be implemented in bigger scale then it is possible to observe positive effect in economy of Russian Federation. Moreover, saved money by government could be used in form of support for saving measures implementation in buildings with poor conditions and as well for other purposes of state.

REFERENCES

- [1] Federal law from 23.11.2009 N 261-FZ (edited 13.07.2015) "About energy savings and increase of electrical efficiency and about amendments in certain legislative acts of Russian Federation".
- [2] US energy information administration, *International Energy outlook 2016*, [online]. Available on: <https://www.eia.gov/forecasts/ieo/electricity.cfm> [Date accessed 20.10.16]
- [3] Global Energy Statistical Yearbook 2016, *Electricity domestic consumption*, [online]. Available on: <https://yearbook.enerdata.net/world-electricity-production-map-graph-and-data.html#electricity-domestic-consumption-data-by-region.html> [Date accessed 20.10.16]
- [4] Renewable Energy Alaska Project, [online]. Available on: <http://alaskarenewableenergy.org/what-is-energy-efficiency-why-is-it-important/> [Date accessed 15.11.16]
- [5] European commission, Energy, [online]. Available on: <https://ec.europa.eu/energy/en/topics/energy-efficiency/energy-efficiency-directive> [Date accessed 18.11.16]
- [6] Fourth report "On progress achieved towards meeting national energy efficiency targets in the Czech Republic", pursuant to Article 24 of Directive 2012/27/EU "On energy efficiency"
- [7] Breaking energy, *The curious case of Russian energy efficiency*, [online]. Available on: <http://breakingenergy.com/2014/08/01/the-curious-case-of-russian-energy-efficiency/> [Date accessed 15.11.16]
- [8] State program issued by Russian Federation government from 27.11.2010, "Energy saving and increasing energy efficiency program till 2020", N2446-p
- [9] Clime conditions in Tomsk, [online]. Available on: <http://worldgeo.ru/russia/reg70/> [Date accessed 9.2.17]
- [10] KIREEV, E.A. Single line scheme of TP-671-2 and TP-671-2a substations. Department of OGE AHSR TPU
- [11] Data about electrical energy consumption by considered educational building provided by the head of electrical department of TPU. [Received 26.02.2017]
- [12] Tomsk energosbyt, *electrical energy tariff*, [online]. Available on: http://www.ensb.tomsk.ru/corporate_banking/rates_and_prices/ [Date accessed 17.12.16]
- [13] Tomsk Polytechnic University, [online]. Available on: <http://portal.tpu.ru/> [Date accessed 4.1.17]
- [14] Date and time, *daytime duration in Tomsk*, [online]. Available on: <http://dateandtime.info/ru/citysunrisesunset.php?id=1489425> [Date accessed 4.1.17]
- [15] Weather records, *weather in Tomsk*, [online]. Available on: <http://rp5.ru/> [Date accessed 4.1.17]
- [16] Construction Norms and Regulations SNiP 23-05-95 "Natural and artificial lighting" (approved by regulation of Ministry of Housing and Building of RF from 02.08.1995 N 18-78) (with amendments)
- [17] SINGH, Jas. Public procurement of energy efficiency services: lessons from international experience. Washington, D.C.: ESMAP/Sector Management Assistance Program, c2010. Directions in development (Washington, D.C.). ISBN 0821381024

- [18] SHAPIRO, Ian M. Energy audits and improvements for commercial buildings. ISBN 9781119084167
- [19] JAFARI, A., VALENTIN, V. An optimization framework for building energy retrofits decision making: Elsevier journal – Building and environment, 2017
- [20] Lecture “Calculation of lighting load”, [online]. Available on: <http://portal.tpu.ru:7777/SHARED/g/GARIKI/uchrab/%D0%9B%D0%B5%D0%BA%D1%86%D0%B8%D0%B8/Oswet.pdf> [Date accessed 5.12.16]
- [21] Automatic circuit breaker, [online]. Available on: <http://выключатель-автоматический.рф/Выбор/Выбор%20автомата%20по%20мощности.html> [Date accessed 15.3.17]
- [22] Heat losses calculation software, [online]. Available on: <http://kcad.cz/cz/uvod/> [Date accessed 16.4.17]!
- [23] ČSN EN ISO 13790 “Energy Performance of Buildings - Calculation of energy needs for heating and cooling”
- [24] Fluorescent lamps lifetime duration, [online]. Available on: <http://artillum.ru/lamps/discharge-lamps/45-fluorescent-lamps.html> [Date accessed 3.4.17]
- [25] LED lifetime duration, [online]. Available on: <http://www.compel.ru/lib/ne/2012/2/11-da-budet-cree-svetodiodyi-cree-dlya-vnutrennego-i-naruzhnogo-osveshheniya> [Date accessed 3.4.17]
- [26] Products catalogue of “Lighting technology” company, [online]. Available on: <http://www.ltcompany.com/ru/knowledge/catalogues/> [Date accessed 15.3.17]
- [27] LIHOTKIN, V. S., RODIN, V.V., GUBANOV, D.V. Control automatization of lighting level in public buildings. Science and education actual problems journal, 2014
- [28] Lighting control systems. DISANO company catalogue, [online]. Available on: <http://www.disano.it/ru/products/browsable-catalogues/disano-led-catalogue#sthash.TR1NOdDe.ASH3G2bW.dpbs> [Date accessed 27.3.17]
- [29] SHISHOV, O.V. Programming of relay controllers. Saransk, 2014
- [30] Inflation rate in Russian Federation, [online]. Available on: http://уровень-инфляции.рф/таблица_инфляции.aspx [Date accessed 3.4.17]
- [31] Ministry of economic development of Russian Federation, [online]. Available on: http://economy.gov.ru/minec/activity/sections/macro/prognoz/doc20130325_06 [Date accessed 10.3.17]
- [32] Fluorescent lamps and LED prices, [online]. Available on: <https://www.shop.philips.ru/lighting/lamp.html> [Date accessed 6.3.17]

APPENDICES

Appendix 1 - Educational building plan [13]

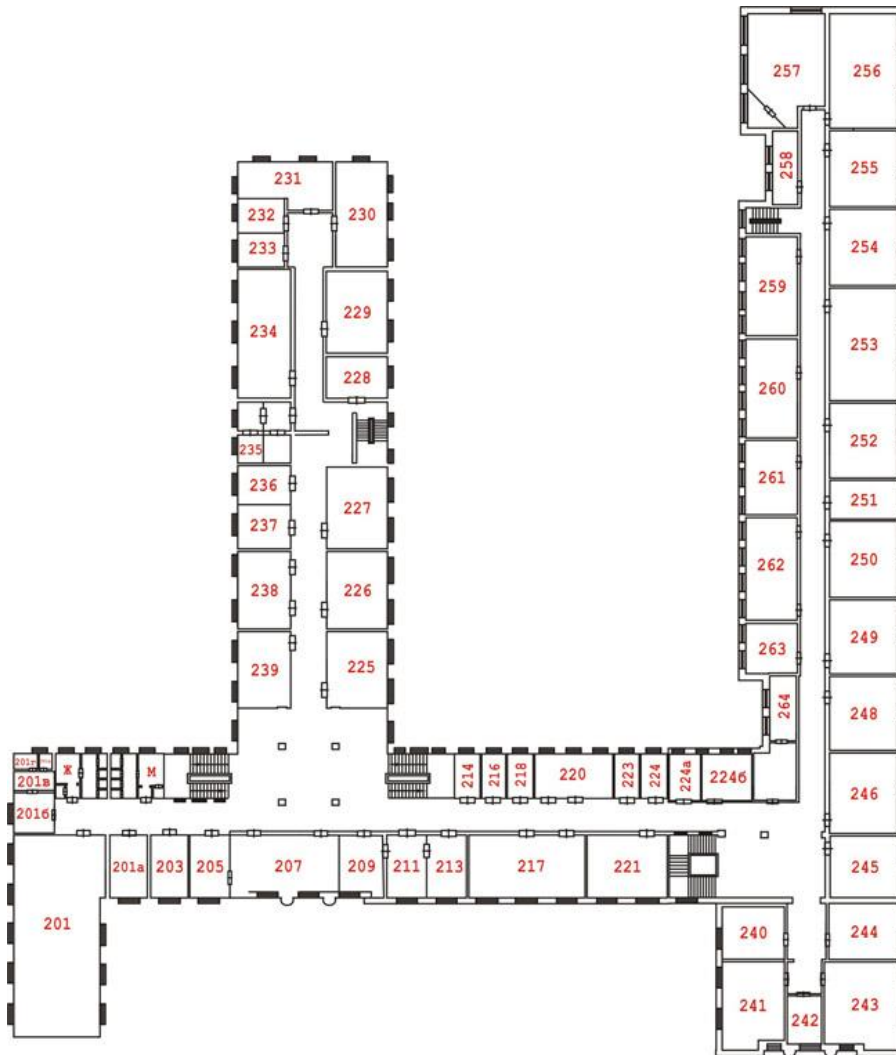

Appendix 3 - External power supply scheme of educational building [10]

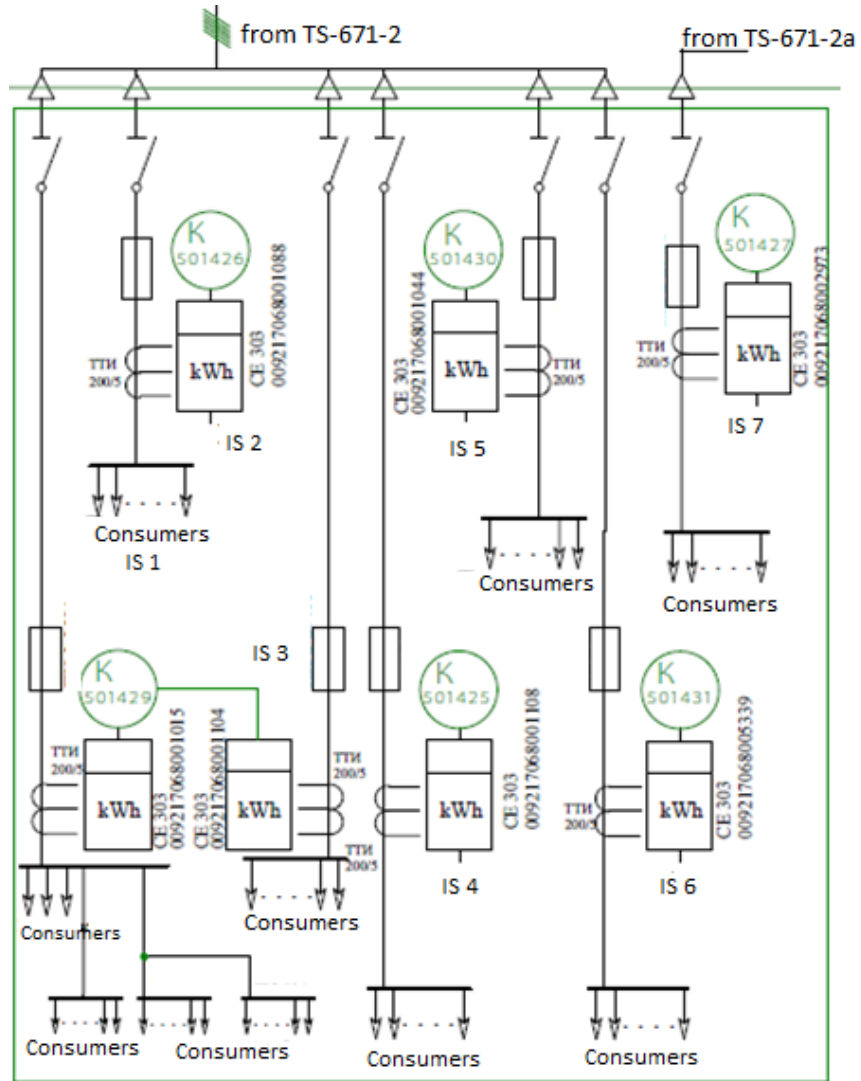

Appendix 4 - Scheme of light sources arrangement in the lecture room

